



P B Z S E R I E S

Intelligent power supply providing arbitrary waveform generation and accurate power simulation!



High Current Support

20V/200A
40V/100A

High Current Support

20V/100A
40V/50A
60V/33.5A
80V/25A

DC POWER SUPPLY

Intelligent Bipolar Power Supply PBZ Series



Peak current output 6 times the rating (PBZ20-20A)

4 models: PBZ20-20 ($\pm 20\text{ V}/\pm 20\text{ A}$), PBZ40-10 ($\pm 40\text{ V}/\pm 10\text{ A}$),
PBZ60-6.7 ($\pm 60\text{ V}/\pm 6.7\text{ A}$) and PBZ80-5 ($\pm 80\text{ V}/\pm 5\text{ A}$)

High Current Support: PBZ SR series (20 V/100 A, 40 V/50 A, 60 V/ 33.5 A, 80 V/25 A) 12 models

High Current Support: PBZ BP series (20 V/200 A, 40 V/100 A) 10 models

USB, GPIB and RS232C standard digital interface

LAN option available (**LXI** compliant)



Real & Flexible



+1
7 new features for opt

- 1 **Waveform Generation**
- 2 **Sequence Feature**
- 3 **Synchronized Operation**
- 4 **Parallel Operation**
- 5 **Unipolar Mode**
- 6 **High-Speed Response**
- 7 **Low Ripple Noise!**
- +1 **Peak Current Output**

*1. 100 kHz for standard models (PBZ20-20, 40-10, 60-6.7,
*2. 150 kHz for "A" models (PBZ20-20A)
*3. "A" models (PBZ20-20A)



Peak current
6x
rating
(±120 Apk CV)
(See P4.)

Intelligent Bipolar Power Supply PBZ20-20A



● **USB, GPIB and RS232C standard digital interface
(LAN option available)**

The PBZ20-20A Intelligent Bipolar Power Supply takes a fresh new look at bipolar power supply design, allowing for peak current up to 6 times that of the rated output. As a result, peak currents exceeding the 20 A rating can be easily compensated with a single unit, eliminating the need to connect multiple units in parallel, and greatly cutting costs.

The primary source of energy for modern-day vehicular components is the car battery, but factors such as electronic circuit chattering as well as inrush caused by the engine can be cause for concern. Disturbances in the power source caused by these factors make programming and evaluating power supply fluctuation waveforms an absolute must.

The PBZ20-20A Intelligent Bipolar Power Supply has the high speed response to meet the demands of voltage fluctuation tests (Pulse2b, Pulse4, etc.) for international standards such as the ISO16750-2 and ISO7637-2 as well as for the increasingly complicated fluctuation waveform tests required by automotive

manufacturers. The PBZ20-20A is also equipped to easily comply with the steady increase of electronic components per vehicle (high power capacitors, etc.) and total current (esp. peak current) required in modern-day automotive testing.

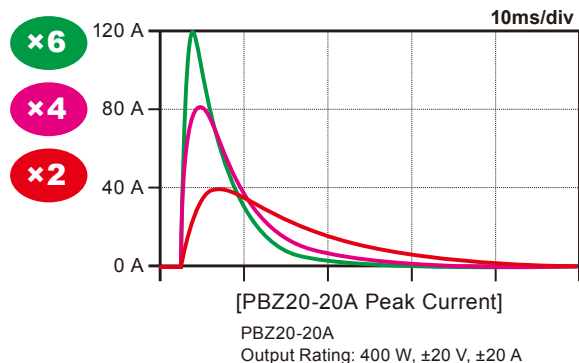

Intelligent power supply providing arbitrary waveform generation and accurate power simulation!



imum test simulation!

on

ation

se 100 kHz^{*1}/150 kHz^{*2} (CV)

t (6x Rating)^{*3}

80-5)



Intelligent Bipolar Power Supply PBZ series

- PBZ20-20 (±20 V/±20 A)
- PBZ60-6.7 (±60 V/±6.7 A)
- PBZ40-10 (±40 V/±10 A)
- PBZ80-5 (±80 V/±5 A)



●USB, GPIB and RS232C standard digital interface
(LAN option available)

The PBZ is a series of bipolar DC programmable power supplies that can smoothly pass through zero to provide ± voltage and ± current without changing the output terminals. The PBZ is capable of 4-quadrant operation, meaning that it is capable of both sourcing and sinking power, ideal for driving both inductive and capacitive loads.

This power supply comes equipped with a built-in function generator, allowing for easy waveform and sequence generation. The output current of the PBZ can be expanded among multiple units by using the synchronization feature. The switching + linear design of the PBZ has allowed for a 40% reduction in weight (approx. 22 kg) while achieving extremely high-speed operation (CV mode: 100 kHz) and low ripple noise.

Four quadrant (bipolar) operation diagram

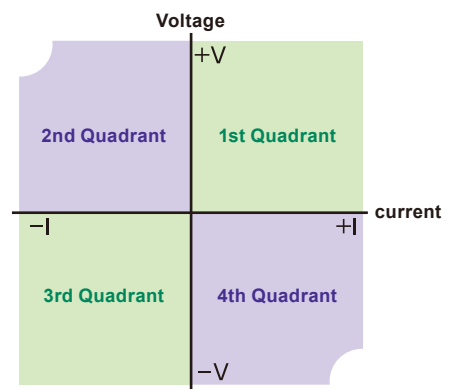

- : Voltage and current in same direction (source)
- : Voltage and current in opposite directions (sink)

Primary Features

+1

"A" models

Peak Current Output (6x Rating)

Inrush current output up to 6 times the rating! (CV mode)

The PBZ20-20A is capable of generating a short-term peak current up to 6 times the rating when current response is set to 1ms in CV mode. Other response settings will activate the current limit and allow the operator to safely use the device without 6x peak current output. When current response is set to 1ms, the PBZ20-20A automatically decreases response speed and allows for peak current output while the current limit is deactivated. This means that the current function will be active at all times when short-term peak current is not output and will have no effect on current response in CC mode. Short-term peak current output is available in both bipolar and unipolar mode.

Recommended Peak Current Duration and Range (Protection)

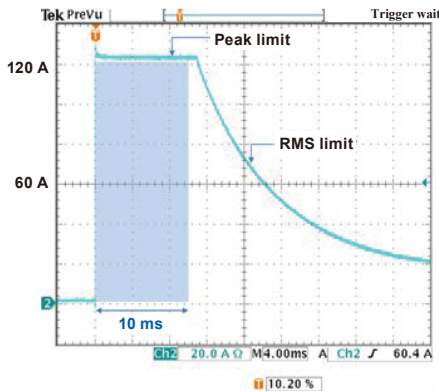

We recommend a maximum peak current output of up to 6 times the rating (5 times depending on output voltage) within a duration of 10ms (blue area on left). A minimum interval of at least 1 second is required between peak currents, as shorter intervals can cause hardware malfunction. The figure on the left shows the peak and rms current limits when the output is shorted.

- In the peak limit area, peak current is capped at 105% of 6x the rating and can be retained for at least 10 ms.
- There are cases where normal waveforms cannot be generated within the peak limit area. Current limits will still be active ensuring the safety of the operator.
- In the rms limit area, the peak current is limited by the rms value. The current will decrease down to the rated current according to the duration settings.
- When sinking power in quadrant 2 and 4, power will be limited after 10 ms and the regular current limit will be activated.

Maximum Peak Current and Terminal Voltage Output

Example: PBZ20-20A

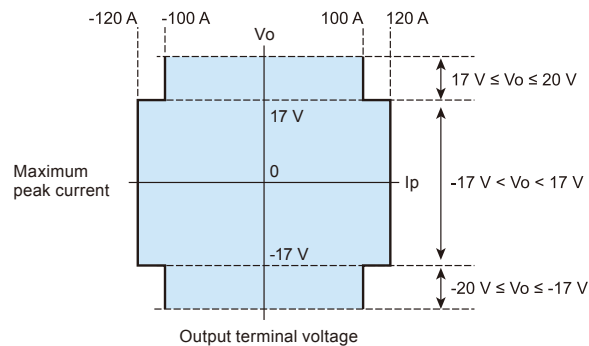

Power variation test

PBZ20-20A 6 parallel
720 A peak compatible
Voltage rising edge/falling edge waveform
Ch1 5 V/div
Ch2 200 A/div

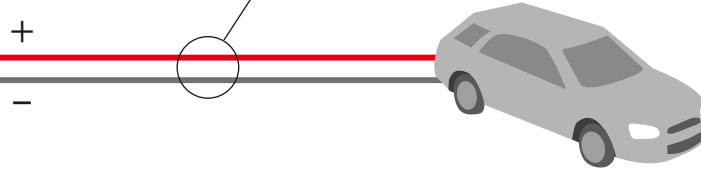
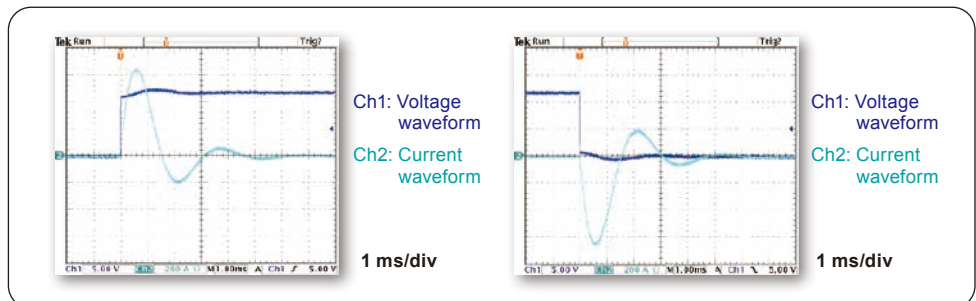
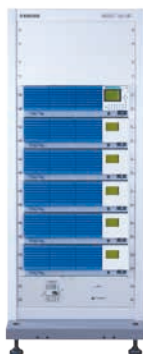

1

"A" models Standard models

Waveform Generation

Built-in function generator for customizable waveform generation!

In addition to basic sine, square and triangular waveforms, the PBZ allows the operator to customize up to 16 user-defined waveforms with the internal function generator. Amplitude, frequency, start phase, frequency sweep and square wave duty can be programmed as needed. 16 user-defined waveforms can be freely edited and registered to the PBZ internal memory. The sequence feature (see P6) allows for each step in an individual waveform to be customized in detail for a maximum of 1024 steps among 16 programs. *Waveform editing requires proprietary software (Wavy for PBZ). (See P14.)

3 Basic Waveforms

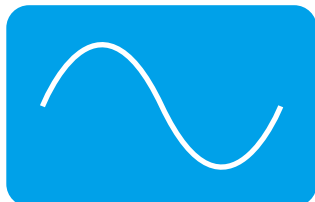

Sine wave



Triangular wave



Square wave

16 User-Defined Waveforms (Default Waveforms)

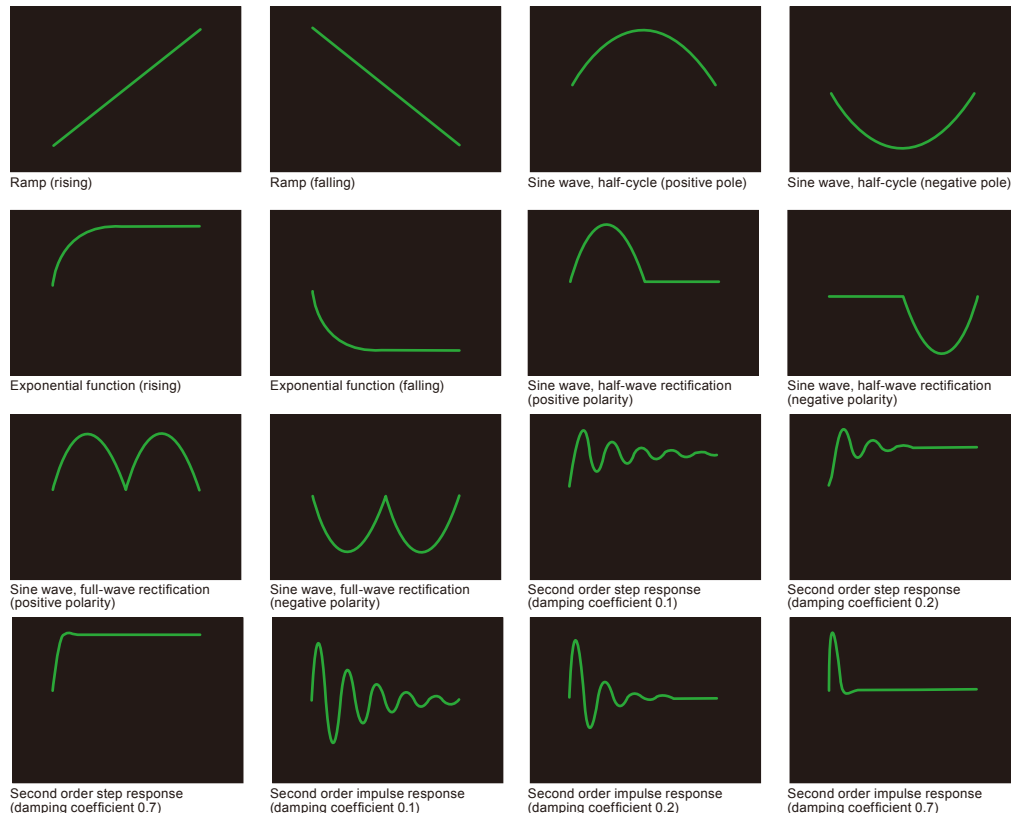

Example Applications Expanded Through Waveform Generation

Power fluctuation test for automotive electronic components

Car navigation systems, others

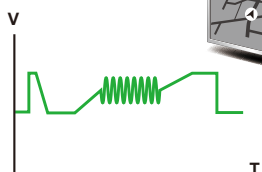

Rechargeable battery charge/discharge test

Various rechargeable batteries

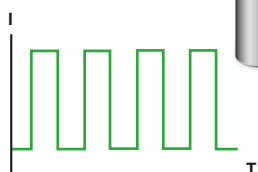

Simulated battery charge/discharge test

Digital cameras, cellular phones, and others

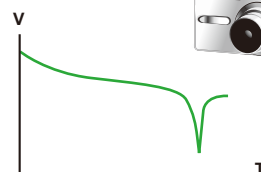

Constant current source for pulse plating

HDD, others

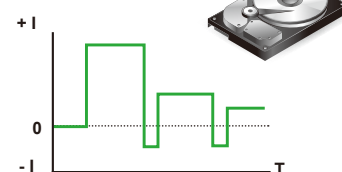

Ripple overlap test

Various electrical storage elements

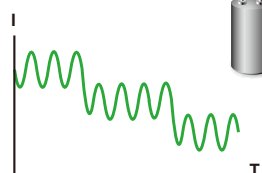

DC motor durability test

Printers, others

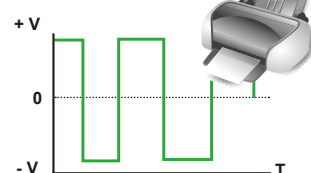

Constant current source for magnetic field generation

Helmholtz coil

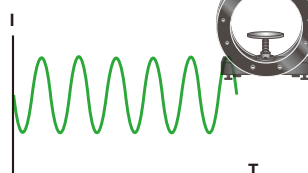

Others

- Contact resistance test for breakers and relays
- Characteristics test for solenoid valves, coils and others

2

Sequence Feature

Sequence customization for convenient waveform generation!

"A" models Standard models

The basic sine, triangular and square waveforms (as well as the 16 user-defined waveforms) can be programmed per sequence step, allowing for easy creation of complex sequences.

Sequences are composed of up to 1024 steps, which can be allocated among a maximum of 16 programs. The script function allows for multiple programs to be combined and executed as needed.

As shown on the right, Program 1 uses 8 steps, allowing for 1016 steps to be allocated among the remaining 15 programs. (1024 - 8 = 1016 steps)

● Step and Program Settings

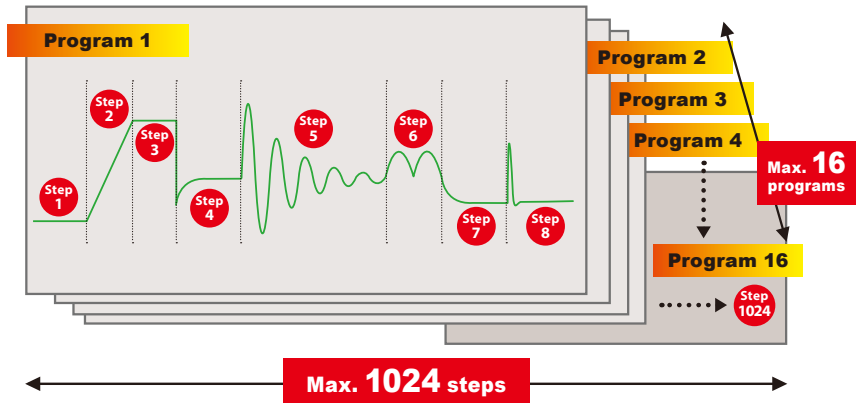

The script function allows the operator to specify the sequence and number of repetitions for set programs. A maximum of 50 rows can be assigned to 1 script for both CV and CC mode.

● Example of Script

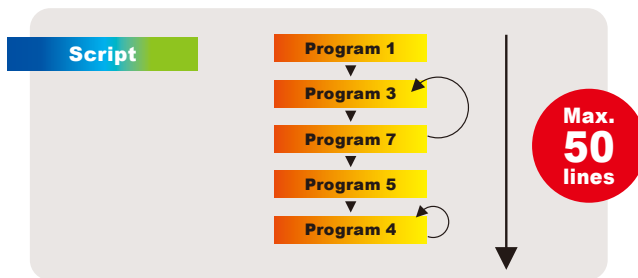

3

Synchronized Operation

Seamless sequence execution with no deviation between synchronized units!

"A" models Standard models

This feature allows the user to synchronize the output of multiple PBZ units when executing a sequence, preventing any deviations from occurring even during a long sequence. *Excluding start up delay of up to 1 μs

Synchronized Multichannel Voltage Variation Tests for Automotive Standards!



[Multichannel voltage variation test example]

Power for automotive vehicles is supplied by the battery, but the power is activated by multiple internal electronic components (+B→ACC→IG) turning ON/OFF in a specific order. There are an extremely large number of electronic components that can cause instability within the automobile, including engine start-up and electrical circuit chattering. Therefore, problems caused by this instability such as power interruptions and fluctuations can be planned for and avoided by performing rigorous voltage variation tests on all channels for automotive electronic components.

[Car navigation system]

- CH1 : +B LINE** Power continuously supplied by the battery is distributed to components such as clocks and memory devices.
- CH2 : ACC LINE** The power supply for car navigation systems are turned ON via the ignition switch's ACC contact. After the switch is activated, real-time navigation, radio, etc. become possible.
- CH3 : ILL LINE** Backup power supply line (ILL) that directly pulls up +B, IG, and ACC.

■ Example of using synchronized operation

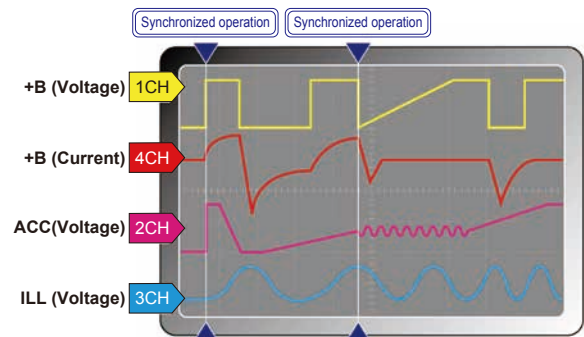
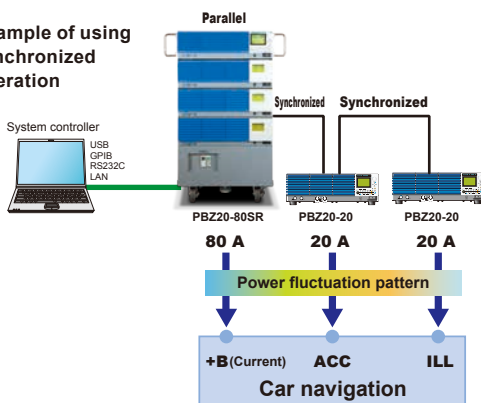

4

"A" models Standard models

Parallel Operation Easily increase capacity!

This feature allows the user to increase the output current by connecting multiple units in parallel. This setup can easily be completed with 2 identical models and the optional parallel operation kit. For systems that require more than 3 units, please refer to the PBZ-SR Series (P16). For systems that require more than 6 units, please contact your local Kikusui distributor. (Standard models)

Parallel operation kit (option)

The optional accessory kit for connecting 2 PBZ units in parallel (same model). Please select the following kit that best fits your testing requirements. *Bracket is not included for PK02-PBZ and PK03-PBZ

For Desktop use: PK01-PBZ

Contents: Bracket, Insulating sheet, OUTPUT terminal connection bar, Parallel output terminal cover, Bracket screws (M4-8L), Spacer, Load wire screw (M5-10L), Parallel operation signal cable

For Rack-mounted system: PK02-PBZ (For EIA inch size)

Contents: Insulating sheet, OUTPUT terminal connection bar, Load wire screw (M5-10L), Parallel operation signal cable

For Rack-mounted system: PK03-PBZ (For JIS metric size)

Contents: Insulating sheet, OUTPUT terminal connection bar, Load wire screw (M5-10L), Parallel operation signal cable

6

"A" models Standard models

High-Speed Response 100 kHz^{*1} / 150 kHz^{*2} (CV mode)

100 kHz/150 kHz frequency specifications (CV). The excellent waveform quality combined with the ultra-fast rise/fall time of 3.5 μ s allow the PBZ to reproduce a wide variety of waveforms of the highest quality.

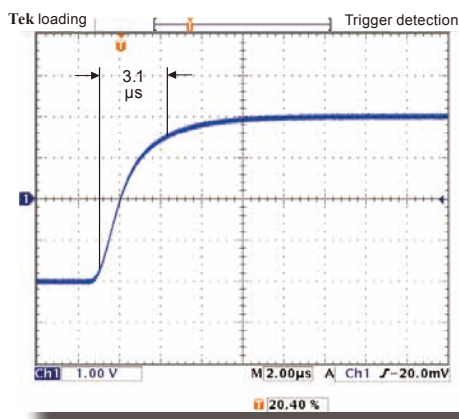

▲ Rise time example when 3.5 μ s response is set

*1. 100 kHz for standard models (PBZ20-20, 40-10, 60-6.7, 80-5)
*2. 150 kHz for "A" models (PBZ20-20A)

5

"A" models Standard models

Unipolar Mode Full operation in quadrant 2

The unipolar function is unique to the PBZ. "Unipolar mode" allows the PBZ to apply current in both directions (source and sink) while current flows in a single direction. As seen in the diagram below, this feature allows the user full operation in the 1st and 2nd quadrants. Unipolar mode allows the user to bypass power restrictions (PBZ20-20: 100 W, PBZ40-10: 180 W) present in the 2nd and 4th quadrants when in bipolar mode.

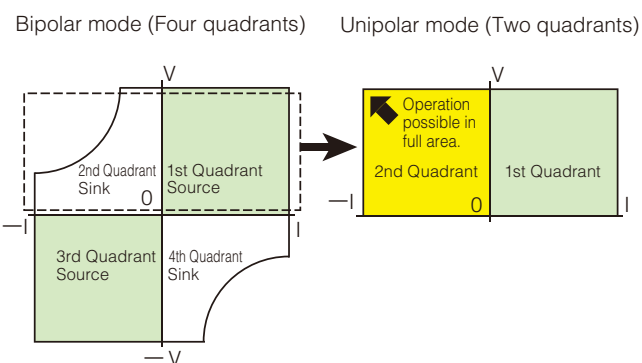

7

"A" models Standard models

Low Ripple Noise Excellent waveform quality

The excellent waveform quality of the PBZ minimizes noise effects on simulations and pulse-driven devices.

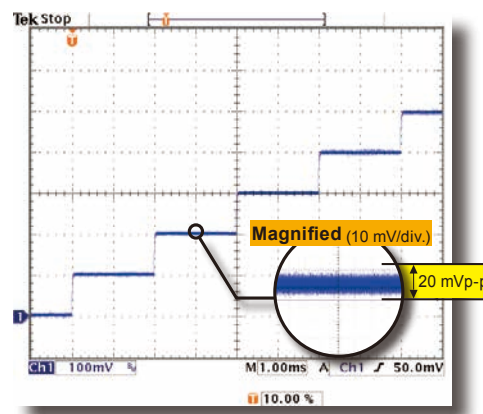

▲ Sample of actual 0.1 V step waveform
Ripple 2 mVrms, noise 20 mVp-p (PBZ20-20)

*PBZ40-10 :Ripple 4 mVrms, noise 20 mVp-p
PBZ60-6.7 :Ripple 4 mVrms, noise 30 mVp-p
PBZ80-5 :Ripple 4 mVrms, noise 30 mVp-p

Other Features

40 % lighter than previous models

The switching + linear design of the PBZ has allowed for a 40% reduction in weight (approx. 22 kg) resulting in the improved accessibility and portability of bench-top test systems.

Expanded measurement

Built-in measurement features allow for easy testing without the need for multimeters and other measurement devices. Furthermore, the measurement time TRIG signal allows the operator to program measurement start time and measurement delay time.

Setting Item			
Voltage measurement	DC	Measurement range (resolution)	120 % of rating (0.001 V)
		Accuracy *1	±(0.05 % of reading + 0.05 % of rating)
	AC	Measurement range (resolution)	120 % of rating/CF (0.001 V)
	DC+AC	Measurement range (resolution)	120 % of rating (0.001 V)
		Accuracy *1, *2	±(0.5 % of reading + 0.1 % of rating) (5 Hz to 10 kHz)
	±(1 % of reading + 0.2 % of rating) (10 Hz to 50 kHz)		
±(2 % of reading + 0.2 % of rating) (50 Hz to 100 kHz)			
PEAK	Measurement range (resolution)	120 % of rating (0.01 V)	
PEAK	Accuracy *1, *3	±(0.5 % of rating)	
Current measurement	DC	Measurement range	120 % of rating (0.001 A)
		Accuracy *1	±(0.3 % of reading + 0.1 % of rating)
	AC	Measurement range (resolution)	120 % of rating/CF (0.001 A)
	DC+AC	Measurement range (resolution)	120 % of rating (0.001 A)
		Accuracy *1, *2	±(3 % of reading + 0.1 % of rating) (5 Hz to 10 kHz)
	±(10 % of reading + 1 % of rating) (10 Hz to 100 kHz)		
PEAK	Measurement range (resolution)	120 % of rating (0.01 A)	
PEAK	Accuracy *1, *3	±(0.5 % of rating)	
Measurement time			100 µs to 3600 s

*1. At ambient temperature of 18 °C to 28 °C

*2. When the input signal is a sine wave with a crest factor of 3 or less within the prescribed frequency range and the measurement time is no more than 10 times the period of the input signal

*3. Peak value of a 1 kHz sine wave

Memory functions

- **Preset memory**
Stores setting conditions most often used. Three memory slots are available for CV mode and CC mode. Settings stored are limited to DC signal and AC signal.
- **Setup memory**
This can be used as general memory storing all basic settings. Up to 10 memories can be set, regardless of mode.

CC/CV selection feature

Select CV mode when using constant-voltage, and CC when using constant-current. The voltage and current uppower/lower limits utilize a "V" and "I" limit function.

Response switching

Response speeds can be switched in both CV and CC mode. The output voltage and current rise/fall time will be effected by the response settings. (Response time setting indicates rise/fall time.)

Setting description	CV mode Voltage response	CC mode Current response			
		PBZ20-20	PBZ40-10	PBZ60-6.7	PBZ80-5
Selectable values	3.5 µs	35 µs	70 µs	35 µs	35 µs
	10 µs	100 µs	100 µs	100 µs	100 µs
	35 µs	350 µs	350 µs	350 µs	350 µs
	100 µs	1 ms	1 ms	1 ms	1 ms
Factory default setting	3.5 µs	35 µs	70 µs	35 µs	35 µs

Protections (overvoltage, overcurrent, V-I LIMIT, overheating)

- **Overvoltage and overcurrent protection**
This protection activates when the output voltage/current exceeds the protective trip points. The protective trip points can be set separately in both positive (+) and negative (-) polarities. The following three options can be selected when a protection is activated.
 - ▶ **OUTPUT-OFF** : Output is turned OFF.
 - ▶ **PPOWER-OFF**: Output and POWER switch are turned OFF.

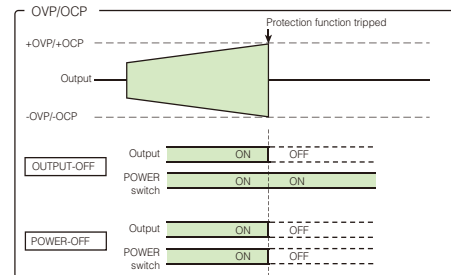

▶ V/I-LIMIT

Prevents voltage and current exceeding the protection trip points. (Output is not turned OFF.) The V-I/LIMIT function allows the unit to automatically switch from CV mode to I-LIMIT and from CC mode to V-LIMIT. This also allows the unit to automatically switch from CV mode to CC mode, and from CC mode to CV mode.

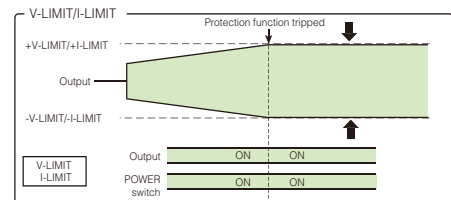

- **Overheating protection**
This protection is activated when the PBZ temperature reaches abnormally high levels. This protection protects the product from test environments that exceed the ambient temperature, or when sufficient ventilation has not been provided for the intake and exhaust ports.

Soft start and soft stop function

The soft start feature allows the user to gradually increase the output to a given value when turned ON. With soft stop, the user can gradually decrease the output from a given value to 0 when turned OFF. Soft start and stop times can only be set for DC settings. If the OUTPUT key is pressed while soft start or soft stop is in progress, the operation will be cancelled and output turned OFF.

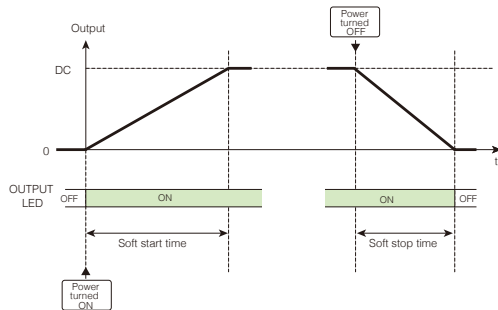

Fine settings function

Fine adjustments (increase, decrease) can be made to the DC setting value.

Input range

- PBZ20-20A/PBZ20-20
CV: DC setting value ± 1.0000 V, resolution 0.0001 V
CC: DC setting value ± 1.0000 A, resolution 0.0001 A
- PBZ40-10
CV: DC setting value ± 2.0000 V, resolution 0.0001 V
CC: DC setting value ± 0.5000 A, resolution 0.0001 A
- PBZ60-6.7
CV: DC setting value ± 3.0000 V, resolution 0.0002 V
CC: DC setting value ± 0.3350 A, resolution 0.0001 A
- PBZ80-5
CV: DC setting value ± 4.0000 V, resolution 0.0002 V
CC: DC setting value ± 0.2500 A, resolution 0.0001 A

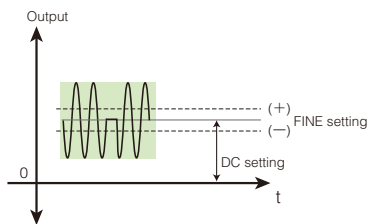

Key lock

3 levels of key lock are available.

- Disable all key operations other than OUTPUT, RECALL, and A,B,C memory functions.
- Disable all key operations other than OUTPUT.
- Disable all key operations.
(excluding KEY LOCK (SHIFT + LOCAL) KEY)

Remote sensing function

Remote sensing function stabilizes the load terminal output voltage by compensating for voltage drops caused by resistance in the load wires. This function can be used in CV mode with one-way compensation of up to approx. 0.5 V. Please make sure to select load wires with sufficient current capacity so that load wire voltage drop does not exceed the voltage compensation.

Output voltage/current monitor

- Voltage monitor
Rear panel (J1 connector)
0 to ± 2 V from 0 V to \pm rated voltage
- Current monitor
Front panel (BNC terminal)
0 to ± 2 V from 0 A to \pm rated current
Frequency characteristics DC to 20 kHz (-3 dB)
Rear panel (J1 connector)
0 to ± 2 V from 0 A to \pm rated current

External control

- External output ON/OFF ● Shutdown

Status signal output

CV, CC, OUTPUT, and ALARM are output.

External signal input (external voltage control)

The PBZ series is compatible with two types of input signals.

- The DC signal from the internal signal source can be controlled via external voltage at the rear panel (J1 connector) from DC control signal 0 to approx. ± 10 V.

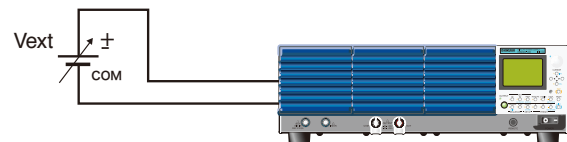

- Front panel EXT SIG IN (BNC terminal) input signal.
Composed of a bipolar amplifier using EXT SIG IN (BNC terminal) as the input signal.
The amplifier gain, polarity (inverted, non-inverted) and offset can be set with a maximum input voltage of ± 12 V_{peak}, maximum input impedance of 10 k Ω , and a common terminal connected to OUTPUT terminal COM.

External signal input (external resistance control)

DC signal of the internal signal source can be controlled using an external variable resistor to change the standard voltage and voltage ratio. With CV and CC mode, the operator can control both voltage and current, respectively. The output is the sum of the external resistor setting, DC panel setting, and remote controller setting.

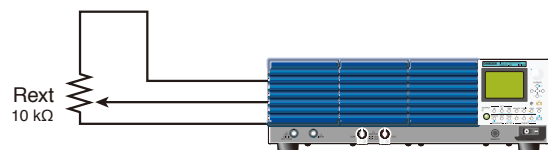

Temperature-sensitive fan motor

Internal temperature is detected and maintained with an internal fan cooling system.

Interface

USB, GPIB and RS232C standard digital interface.
For LAN (option), see P13.

Specifications

AC input, rated output		PBZ20-20A	PBZ20-20	PBZ40-10	PBZ60-6.7	PBZ80-5
AC input	Nominal input voltage	100 Vac to 240 Vac, 50 Hz to 60 Hz				
	Voltage and frequency range	90 Vac to 250 Vac, 47 Hz to 63 Hz				
	Current	10 Aac or less (when connected to a rated load)				
	Inrush current (1 ms or more)	20 Apeak or less(input 100 V) 40 Apeak or less(input 200 V)	40 Apeak or less			
	Power	900 VA or less (when connected to a rated load)				
Rated output	Power factor	0.95 TYP (when the input voltage is 100 V and when connected to a rated load)				
	Output power	400 W		402 W		400 W
	Output voltage	±20 V	±20 V	±40 V	±60 V	±80 V
	Output current	±20 A	±20 A	±10 A	±6.7 A	±5 A
	Peak current *1	±120 Apeak (TYP) *2 ±100 Apeak (TYP) *3	—	—	—	—
	Isolation voltage	500 Vdc, Only the output's COM terminal can be grounded.				

*1. Set the peak current output time to 10 ms or more, the repetition interval to 1 s or more, and the CV or CC mode current response to 1 ms.

*2. (-17 V < Output terminal voltage < +17 V) *3. (-20 V ≤ Output terminal voltage ≤ +20 V)

Constant voltage (CV mode)		PBZ20-20A	PBZ20-20	PBZ40-10	PBZ60-6.7	PBZ80-5	
DC voltage	Setting range *1	Bipolar mode	0.000 V to ±21.000 V	0.000 V to ±21.000 V	0.000 V to ±42.000 V	0.000 V to ±63.000 V	0.000 V to ±84.000 V
		Unipolar mode	0.000 V to 21.000 V	0.000 V to 21.000 V	0.000 V to 42.000 V	0.000 V to 63.000 V	0.000 V to 84.000 V
		Fine feature	±5 % of rtg				
	Setting resolution	0.001 V (0.0001 V for the fine feature)			0.002 V (0.0002 V for the fine feature)		
Setting accuracy *2	± (0.05 % of setting + 0.05 % of rtg)						
Temperature coefficient	±100 ppm/°C of rtg (TYP)						
AC voltage	Setting range *1	0.00 Vpp to 42.00 Vpp	0.00 Vpp to 42.00 Vpp	0.00 Vpp to 84.00 Vpp	0.00 Vpp to 126.00 Vpp	0.00 Vpp to 168.00 Vpp	
	Setting resolution	0.01 V			0.1 V		
	Setting accuracy *3	±0.5 % of rtg					
AC frequency	Setting range	0.01 Hz to 200.00 kHz	0.01 Hz to 100.00 kHz				
	Setting resolution	0.01 Hz					
	Setting accuracy	±200 ppm					
	Sweep	Linear and logarithmic					
AC waveform	Sweep time	100 μs to 1000 s (resolution of 100 μs)					
	Type	Sine wave, square wave, triangle wave, and 16 user-defined arbitrary waveforms					
	Start phase	0 ° to 359 °					
	Square wave duty cycle	0.1 % to 99.9 % (f < 100 Hz), 1 % to 99 % (100 Hz ≤ f < 1 kHz), 10 % to 90 % (1 kHz ≤ f < 10 kHz), and fixed to 50 % (10 kHz < f)					
Constant voltage characteristics	Frequency response *4	DC to 150 kHz (TYP)		DC to 100 kHz (TYP)			
	Response *5, *6	2.3 μs, 6.7 μs, 23 μs, 67 μs (TYP)	3.5 μs, 10 μs, 35 μs, 100 μs (TYP)				
	Overshoot	5 % or less (TYP)					
	Ripple noise	(p-p) *7	20 mV (TYP)		30 mV (TYP)		
		(rms) *8	2 mV (TYP)	2 mV (TYP)	4 mV (TYP)	4 mV (TYP)	
	Load effect *9	±(0.005 % of setting + 1 mV)					
Source effect *10	±(0.005 % of setting + 1 mV)						

*1. The peak value of the sum of the DC voltage and AC voltage is limited by the DC voltage's settable range.

*2. At an ambient temperature between 18 °C and 28 °C.

*3. At an ambient temperature between 18 °C and 28 °C, with a 1 kHz sine wave, 3.5 μs response, and no load.

*4. A frequency where the amplitude ratio of the output voltage to the external signal input voltage is -3 dB (when the reference frequency is 1 kHz, the response is 3.5 μs, and when a rated load is connected).

*5. The rise or fall time (at rated load; excluding when output is turned on and off). The frequency response is based on the specified response setting (frequency bandwidth = 0.35/rise time).

*6. Rise time: The time it takes for the output voltage to rise from 10 % to 90 % of the rating when the output voltage is changed from 0 V to the rated voltage.

Fall time: The time it takes for the output voltage to fall from 90 % to 10 % of the rating when the output voltage is changed from the rated voltage to 0 V.

*7. The measurement frequency bandwidth is 10 Hz to 20 MHz (at the output terminals).

*8. The measurement frequency bandwidth is 10 Hz to 1 MHz (at the output terminals).

*9. The change in the output voltage in response to a change in the output current from 0 % to 100 % of the current rating (measured at the sensing terminals when remote sensing is used).

*10. The change in the output voltage in response to a ±10 % change in the input voltage in reference to the nominal input voltage (measured at the sensing terminals when remote sensing is used).

Constant current (CC mode)		PBZ20-20A	PBZ20-20	PBZ40-10	PBZ60-6.7	PBZ80-5	
DC current	Setting range *1	Bipolar mode	0.000 A to ±21.000 A	0.000 A to ±21.000 A	0.000 A to ±10.500 A	0.000 A to ±7.035 A	0.000 A to ±5.250 A
		Unipolar mode					
		Fine feature	±5 % of rtg				
	Setting resolution	0.001 A (0.0001 A for the fine feature)					
Setting accuracy *2	±0.3 % of rtg						
Temperature coefficient	±100 ppm/°C of rtg (TYP)						
AC current	Setting range *1	0.00 App to 42.00 App	0.00 App to 42.00 App	0.00 App to 21.00 App	0.00 App to 14.07 App	0.00 App to 10.50 App	
	Setting resolution	0.01 A					
	Setting accuracy *3	±0.5 % of rtg					
AC frequency	Setting range	0.01 Hz to 200.00 kHz	0.01 Hz to 100.00 kHz				
	Setting resolution	0.01 Hz					
	Setting accuracy	±200 ppm					
	Sweep	Linear and logarithmic					
AC waveform	Sweep time	100 μs to 1000 s (resolution of 100 μs)					
	Type	Sine wave, square wave, triangle wave, and 16 user-defined arbitrary waveforms					
	Start phase	0 ° to 359 °					
	Square wave duty cycle	0.1 % to 99.9 % (f < 100 Hz), 1 % to 99 % (100 Hz ≤ f < 1 kHz), 10 % to 90 % (1 kHz ≤ f < 10 kHz), and fixed to 50 % (10 kHz < f)					
Constant current characteristics	Frequency response *4	DC to 15 kHz (TYP)	DC to 10 kHz (TYP)	DC to 5 kHz (TYP)	DC to 10 kHz (TYP)		
	Response *5, *6	23 μs, 67 μs, 230 μs, 0.67 ms (TYP)	35 μs, 100 μs, 350 μs, 1 ms (TYP)	70 μs, 100 μs, 350 μs, 1 ms (TYP)	35 μs, 100 μs, 350 μs, 1 ms (TYP)		
	Overshoot	5 % or less (TYP)					
	Ripple noise (rms) *7	3 mA (TYP)					
	Load effect *8	±(0.01 % of setting + 1 mA)					
	Source effect *9	±(0.01 % of setting + 1 mA)					

*1. The peak value of the sum of the DC current and AC current is limited by the DC current's settable range.

*2. At an ambient temperature between 18 °C and 28 °C.

*3. At an ambient temperature between 18 °C and 28 °C, with a 100 Hz sine wave, 35 μs response, and a shorted output.

*4. A frequency where the amplitude ratio of the output current to the external signal input voltage is -3 dB (when the reference frequency is 100 Hz, the response is 35 μs, and a rated load is connected). The frequency response changes according to the load impedance. When the load impedance increases, the frequency response decreases.

*5. The rise or fall time (at rated load; excluding when output is turned on and off). The rise and fall times change according to the load impedance.

*6. Rise time: The time it takes for the output current to rise from 10 % to 90 % of the rating when the output current is changed from 0 A to the rated current.

Fall time: The time it takes for the output current to fall from 90 % to 10 % of the rating when the output current is changed from the rated current to 0 A.

*7. The measurement frequency bandwidth is 10 Hz to 1 MHz (when the output voltage is in the range of 10 % to 100 % of the rated output voltage).

*8. The change in the output current in response to a change in the output voltage from 10 % to 100 % of the voltage rating.

*9. The change in the output current in response to a ±10% change in the input voltage in reference to the nominal input voltage (when the output voltage is in the range of 10 % to 100 % of the voltage rating).

Unless specified otherwise, the specifications are for the following settings and conditions.

• The warm-up time is 30 minutes (with current flowing).

• TYP: These are typical values that are representative of situations where the PBZ operates in an environment with an ambient temperature of 23 °C.

• These values do not guarantee the performance of the PBZ.

• rtg: Indicates the rated voltage or current.

• setting: Indicates a setting.

• rdng: Indicates the readout value of a measured result.

• rtg/CF: The rated voltage or rated current divided by CF (crest factor).

• The polarity of the output voltage and current is defined as follows.

Voltage: Using the output's COM terminal as a reference, the voltage is positive (+) when the OUT terminal is positive and negative (-) when the OUT terminal is negative.

Current: Positive (+) when current flows out from the OUT terminal and negative (-) when current flows into the OUT terminal.

• The output specifications apply to the rear panel output terminals under the following conditions:

The short bar is used to connect the output's COM terminal and chassis terminal. Remote sensing is not being performed. The auxiliary output terminals may not meet the specifications.

• Loads are purely resistive loads.

• Rated loads are defined as follows: When the PBZ is generating its rated voltage, the load causes the rated current to flow. Or, when the PBZ is generating its rated current, the load makes the voltage drop to the PBZ's rated voltage.

Measurement display function		PBZ20-20A	PBZ20-20	PBZ40-10	PBZ60-6.7	PBZ80-5
Voltage measurement	DC	Measurement range (resolution)	±120 % of rtg (0.001 V)			
		Accuracy *1	± (0.05 % of rdng + 0.05 % of rtg)			
		Temperature coefficient	±100 ppm/°C of rtg (TYP)			
	AC	Measurement range (resolution)	±120 % of rtg/CF (0.001 V)			
	DC+AC	Measurement range (resolution)	120 % of rtg (0.001 V)			
	AC and DC+AC	Accuracy *1, *2	±(0.5 % of rdng + 0.1 % of rtg) in the range of 5 Hz to 10 kHz			
			±(1 % of rdng + 0.2 % of rtg) in the range of 10 kHz to 50 kHz			
PEAK	Measurement range (resolution)	±120 % of rtg (0.01 V)				
		±0.5 % of rtg				
Current measurement	DC	Measurement range (resolution)	±120 % of rtg (0.001 A)			
		Accuracy *1	±(0.3 % of rdng + 0.1 % of rtg)			
		Temperature coefficient	±150 ppm/°C of rtg (TYP)			
	AC	Measurement range (resolution)	120 % of rtg/CF (0.001 A)			
	DC+AC	Measurement range (resolution)	120 % of rtg (0.001 A)			
	AC and DC+AC	Accuracy *1, *2	±(3 % of rdng + 0.1 % of rtg) in the range of 5 Hz to 10 kHz			
			±(10 % of rdng + 1 % of rtg) in the range of 10 kHz to 100 kHz			
PEAK	Measurement range (resolution)	±120 % of rtg (0.01 A)				
		±0.5 % of rtg				
Measurement time		100 µs to 3600 s				

*1. At ambient temperature of 18 °C to 28 °C

*2. When the input signal is a sine wave with a crest factor of 3 or less within the prescribed frequency range and the measurement time is the no more than 10 times the period of the input signal

*3. Peak value of a 1 kHz sine wave

Protection functions		PBZ20-20A	PBZ20-20	PBZ40-10	PBZ60-6.7	PBZ80-5
Overvoltage protection	Protection operation *1, *2	OVP or V-LIMIT (output limit). Select whether output or the POWER switch turns off when OVP is activated.				
	Setting range (Bipolar mode)	Select whether (-110 % of rtg ≤ -V.LIM ≤ +V.LIM ≤ +110 % of rtg) or (-110 % of rtg ≤ -OVP ≤ -1% of rtg, +1 % of rtg ≤ +OVP ≤ +110 % of rtg)				
	Setting range (Unipolar mode)	Select whether (-1 % of rtg ≤ -V.LIM ≤ +V.LIM ≤ +110 % of rtg) or (+1 % of rtg ≤ +OVP ≤ +110 % of rtg)				
	Setting resolution	0.01 V				
	Setting accuracy	±1 % of rtg				
Overcurrent protection *3	Protection operation *1, *2	OCP or I-LIMIT (output limit). Select whether output or the POWER switch turns off when OCP is activated.				
	Setting range	Select whether (-110 % of rtg ≤ -I.LIM ≤ -1% of rtg, +1 % of rtg ≤ +I.LIM ≤ +110 % of rtg) or (-110 % of rtg ≤ -OCP ≤ -1 % of rtg, +1 % of rtg ≤ +OCP ≤ +110 % of rtg)				
	Setting resolution	0.01 A				
	Setting accuracy	±1 % of rtg				
Overheat protection	Protection operation	Turns output off when overheating is detected.				
Power limit (sink power)	Bipolar mode	100 W (TYP)	100 W (TYP)	180 W (TYP)	200 W (TYP)	
	Unipolar mode	400 W (TYP)		402 W (TYP)		400 W (TYP)
Control functions		PBZ20-20A	PBZ20-20	PBZ40-10	PBZ60-6.7	PBZ80-5
Internal signal source's DC signal control	Control voltage input	By applying approximately 0 V to approximately ±10.0 V, you can generate 0 % to ±100 % of the rated output.				
	Control voltage ratio input	By using a 10 kΩ external variable resistor to change the internal reference voltage's voltage-divider ratio, you can generate 0 % to ±108 % of the rated output.				
Output ON/OFF control input		External contact input to turn output on and off.				
Shutdown input		External contact input to turn the POWER switch off.				
Status output		CV/CC mode, output on, alarm occurrence				

*1. Voltage is detected at the output terminals.

*2. OVP is activated even when V-LIMIT (voltage limit) is selected. The OVP activation point is approximately ±120 % of rtg.

*3. Peak current at 120 Apeak can be output for 10 ms with the CC mode response set to 1 ms. For other CC mode response settings, the peak current is limited (I.LIM) according to the specified response.

Signal I/O		PBZ20-20A	PBZ20-20	PBZ40-10	PBZ60-6.7	PBZ80-5	
External signal input	Amplifier gain	CV mode	-20.00 to +20.00	-20.00 to +20.00	-40.00 to +40.00	-60.00 to +60.00	-80.00 to +80.00
		CC mode	-20.00 S to +20.00 S	-20.00 S to +20.00 S	-10.00 S to +10.00 S	-6.70 S to +6.70 S	-5.00 S to +5.00 S
		Resolution	0.01 V (CV mode), 0.01 S (CC mode)				0.1 V (CV mode), 0.01 S (CC mode)
	Accuracy *1	±5 % of rtg					
	Maximum allowable input voltage	±12 Vpeak					
Current monitor output	Input impedance	10 kΩ (TYP)					
	Terminal	BNC safety socket. (Common is connected to the output's COM terminal.)					
	Output voltage	2 V with the rated current					
	Output voltage accuracy	±1 % of rtg (TYP)					
Clock input	Output voltage frequency response	DC to 20 kHz					
	Terminal	BNC safety socket. (Common is connected to the output's COM terminal.)					
	Input voltage	0.5 Vp-p to 5 Vp-p					
	Input impedance	1 kΩ TYP (AC coupling)					
Clock output	Lock frequency range	10 MHz ± 200 Hz					
	Lock time	2 s or less					
	Terminal	Isolated BNC. (Common is isolated from the chassis; the maximum isolation voltage is 42 Vpeak.)					
	Output voltage	1 Vp-p TYP (when terminated with 50 Ω)					
Trigger input	Output impedance	50 Ω TYP (AC coupling)					
	Output frequency	10 MHz ± 200 Hz					
	Terminal	BNC. (Common is connected to the chassis.)					
	Input level	H level: 2 V to 5 V. L level: 0 V to 0.8 V (TTL compatible)					
Trigger output	Polarity	H level and L level					
	Pulse width	1 µs or more					
	Delay	1 µs or less					
	Input impedance	10 kΩ TYP (DC coupling)					
Fan-out	Terminal	BNC. (Common is connected to the chassis.)					
	Output level	H level: 2.7 V to 5 V. L level: 0 V to 0.4 V (TTL compatible)					
	Polarity	H level and L level					
	Pulse width	10 µs (TYP)					
Terminal	Rise time and fall time	100 ns or less					
	Terminal	Five units from the PBZ series					
		BNC. (Common is connected to the chassis.)					

*1. When the amplifier gain is at maximum and the PBZ is generating DC.

Interface		PBZ20-20A	PBZ20-20	PBZ40-10	PBZ60-6.7	PBZ80-5
Common specifications	Software protocol	IEEE Std 488.2-1992A		IEEE Std 488.2-1992		
	Command language	Complies with SCPI Specification 1999.0				
RS232C	Hardware	Complies with the EIA232D specifications. D-SUB 9-pin connector (male) *1 Baud rate: 1200, 2400, 4800, 9600, 19200, and 38400 bps Data length: 7 bits or 8 bits. Stop bit: 1 bit or 2 bits. Parity bit: None. Flow control: X-flow or none.				
	Program message terminator	LF during reception, LF during transmission				
GPIB	Hardware	Complies with IEEE Std 488.1-1987 SH1, AH1, T6, L4, SR1, RL1, PP0, DC1, DT1, C0, and E1 24-pin connector (receptacle)				
	Program message terminator	LF or EOI during reception, LF + EOI during transmission				
	Primary address	1 to 30				
USB	Hardware	Complies with the USB 2.0 specifications. Data rate: 12 Mbps (full speed). Socket B type				
	Program message terminator	LF or EOM during reception, LF + EOM during transmission				
	Device class	Complies with the USBTMC-USB488 device class specifications				
LAN (factory option)	Hardware	Complies with the LXI 1.4 Core 2011		Complies with the LXI Class C, Specification 1.2		Complies with the LXI Class C, Specification 1.4
	Communication protocol	VXI-11, SCPI-RAW				
	Program message terminator	LF or END during reception, LF + END during transmission				

*1. Use a cross cable (null modem cable).

*2. Category 5; use a straight cable.

Other functions		PBZ20-20A	PBZ20-20	PBZ40-10	PBZ60-6.7	PBZ80-5
Sequence function	Number of programs	16 programs				
	Number of steps	total of 1024 steps				
	Step time	100 μs to 1000 h (resolution of 100 μs) *1				
Preset memory	3 memory entries					
Setup memory	10 memory entries					
Key lock *2	Select one of three security levels					
Remote sensing	Can be turned on and off. Selectable in CV/CC mode					
Power-on operation	Turn output on or begin execution of the sequence feature					
Soft start and soft stop	Can be turned on and off. Soft start and soft stop time: 0.1 ms to 1000 s.					
Parallel operation *3	On up to two same-model PBZs (using the optional parallel operation kit)					

*1. The DC signal ramp and AC signal amplitude sweep both stop after 1000 s. The AC signal frequency sweep repeats once every 1000 s.

*2. Low: All keys are locked except for the KEY LOCK (SHIFT + LOCAL), OUTPUT, RECALL, A, B, and C keys. (The RECALL key is used to access setup memory entries and the A, B, and C keys are used to access preset memory entries.)

Medium: All keys are locked except for the KEY LOCK (SHIFT + LOCAL) and OUTPUT keys. High: All keys are locked except for the KEY LOCK (SHIFT + LOCAL) key.

*3. Total currents are displayed for the current setting and current measurement in parallel operation.

General specifications		PBZ20-20A	PBZ20-20	PBZ40-10	PBZ60-6.7	PBZ80-5
Environmental conditions	Operating environment	Indoor use, overvoltage category II				
	Operating temperature/humidity	0 °C to +40 °C (+32 °F to +104 °F) / 20 %rh to 85 %rh (no condensation)				
	Storage temperature/humidity	-25 °C to +70 °C (-13 °F to +158 °F) / 90 %rh or less (no condensation)				
Grounding polarity	Only the output's COM terminal can be grounded.					
Isolation voltage	500 Vdc max					
Withstand voltage	Across the primary circuit and chassis	No abnormalities at 1500 Vac for 1 minute				
	Across the primary circuit and the output terminals					
Insulation resistance	Across the primary circuit and chassis	500 Vdc, 30 MΩ or greater (at 70 %rh humidity or less)				
	Across the primary circuit and the output terminals					
	Across the output terminals and chassis					
Earth continuity	Power cord inlet, across the earth pin and chassis	25 Aac, 0.1 Ω or less				
Cooling method	Forced air cooling using variable-speed, heat-sensitive fan					
Safety *1	Complies with the requirements of the following standards. Low Voltage Directive 2014/35/EU EN 61010-1 (Class I *2, Pollution degree 2 *3)					
	Complies with the requirements of the following standard. EMC Directive 2014/30/EU EN 61326-1 (Class A *4), EN 55011 (Class A *3, Group 1 *5), EN 61000-3-2, EN 61000-3-3 Applicable condition All of the cables and wires connected to the PBZ are less than 3 m in length.					
External dimensions (largest part)	429.5 (16.91") W × 128 (5.0") (145 (5.7")) H × 550 (21.65") (595(23.4")) D mm					
Weight	Approx. 22 kg (48.50 lb; just the PBZ)					
Accessories	Power cord: 1 pc. J1 connector (Socket: 1 pc., Protective covers: 2 pairs, Terminals: 30 pc.) Heavy object warning label: 1 pc. CD-ROM: 1 pc.					
	Operation manual (Setup guide 1 pc., Quick reference English 1pc., Japanese 1pc. Safety information 1pc.)					

*1. Does not apply to specially made or modified PBZs.

*2. This is a Class I equipment. Be sure to ground this product's protective conductor terminal. The safety of this product is only guaranteed when the product is properly grounded.

*3. Pollution is addition of foreign matter (solid, liquid or gaseous) that may produce a reduction of dielectric strength or surface resistivity. Pollution Degree 2 assumes that only non-conductive pollution will occur except for an occasional temporary conductivity caused by condensation.

*4. This is a Class A equipment. This product is intended for use in an industrial environment. This product may cause interference if used in residential areas. Such use must be avoided unless the user takes special measures to reduce electromagnetic emissions to prevent interference to the reception of radio and television broadcasts.

*5. This is a Group I equipment. This product does not generate and/or use intentionally radio-frequency energy, in the form of electromagnetic radiation, inductive and/or capacitive coupling, for the treatment of material or inspection/analysis purpose.

Option

■ Communication interface

● LAN

This series is compatible with IEEE488.2 as well as SCPI commands. Downloading the instrument drivers (available on our website) allow for complete control with Excel VBA and LabVIEW, as well as sequence control with our proprietary sequence creation software, Wavy (Wavy for PBZ). LXI compliant LAN interface allows for easy control and monitoring from any web browser.

LXI compliant!!

Easy remote control and monitoring via internal web GUI!

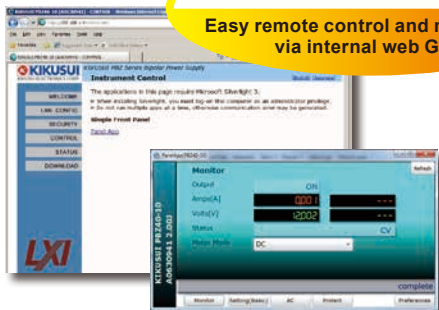

■ Vertical stand

● VS01



*Not included with the PBZ series main unit.

■ Rack mount brackets

● KRB3-TOS

(For EIA inch size)

● KRB150-TOS

(For JIS metric size)

■ Parallel operation kit

● PK01-PBZ

● PK02-PBZ

(For EIA inch size)

● PK03-PBZ

(For JIS metric size)

■ M8 terminal connection kit

● OP01-PBZ-A

Parallel operation kit components

Parallel operation kit PK01-PBZ (option) components

Component	Qty.	Component	Qty.
Brackets	2	Bracket screws (M4-8L)	8
Insulating sheet	1	Spacers	4
OUTPUT terminal connection bars	2	Load wire screws (M5-10L)	2
Parallel output terminal cover	1	Parallel operation signal cable	1

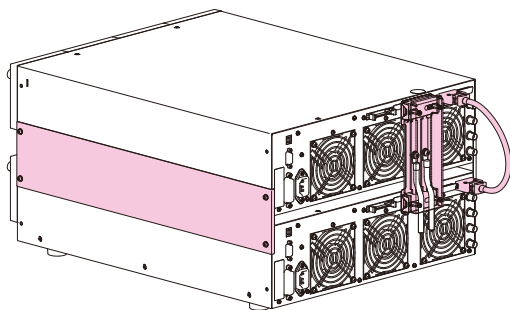

Parallel operation kit PK02-PBZ (For EIA inch size, option), PK03-PBZ (For JIS metric size, option) components

Component	Qty.	Component	Qty.
Insulating sheet	1	Load wire screws (M5-10L)	2
OUTPUT terminal connection bars	2	Parallel operation signal cable	1

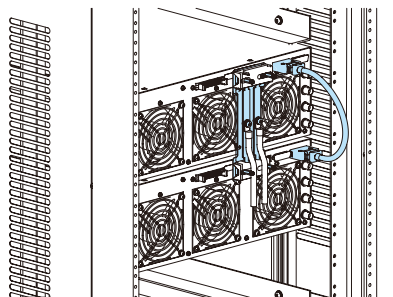

Rack mount bracket: KRB3-TOS or KRB150-TOS is required.

Rear panel



Dimensions

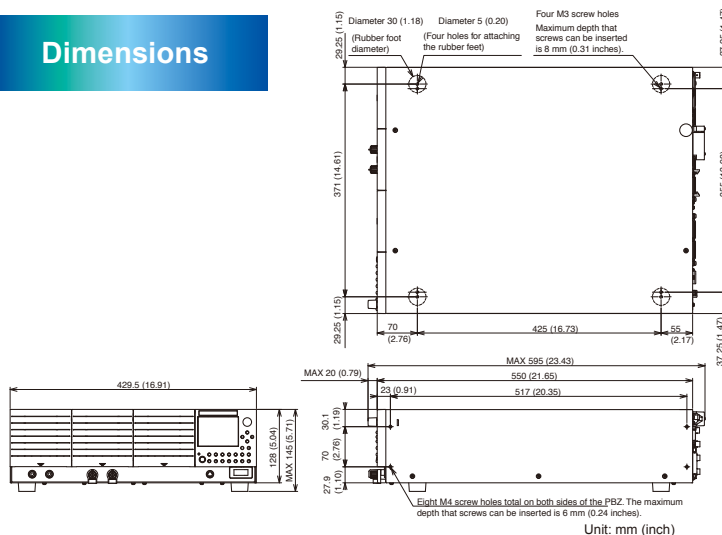

Control Kikusui power supplies and electronic loads with precision!

Expanding the limits of electronic engineering "Wavy" sequence creation software

Wavy series



Wavy for PBZ

- Sequence creation software "Wavy for PBZ"
[Operating environment] Windows Vista / Windows 7 / Windows 8 / Windows 10
*For details, please see our company's homepage.

"Wavy" is an application software that allows for easy sequence creation and control for Kikusui power supplies and electronic loads. No programming knowledge is required as sequences can be easily drawn or created on a spreadsheet!

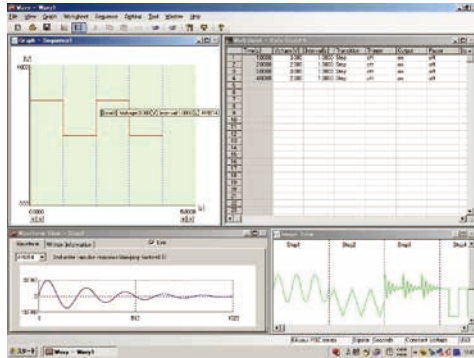

▲Main screen

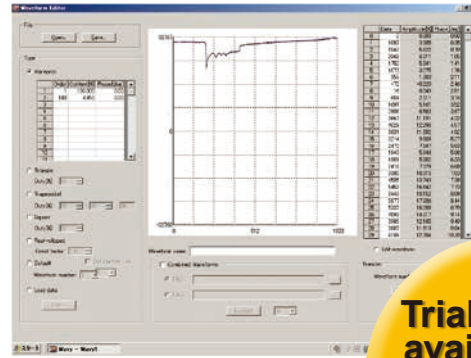

▲User-defined waveform edit screen

- Easy sequence creation/editing for various test conditions.
- Test data can be stored and easily managed for standard routine test conditions.
- Values of sequences in process are easily accessed by placing cursor on the "execution graph."
- Easy prediction of actual output values through "monitor graph" that plots ongoing measurements onto a graph.
- Acquired monitor data can be saved as test results.
- "Waveform image" window has been added to easily keep track of AC signal.
- Arbitrary waveform creation/editing is easier than ever. Simply write the waveform and output immediately.
- Easily "select" and "deselect" sequence steps within the waveform. Activate and deactivate "pause", "trigger function", or "AC waveform" according to your testing requirements.

Trial version available on our website!!

<https://www.kikusui.co.jp/en/download/index.html>

Download!

Example application of "Wavy" software –Step conversion and monitoring–

Easily control your test instruments with a virtual controller

"Wavy" software direct control is perfect for intricate operations too complicated to be performed via the power supply front panel.
"Wavy" software can be used as a convenient "remote control" for power supplies and electronic loads, as well as a simple data logger.

Capable of intricate step changes not possible from a power supply front panel encoder.

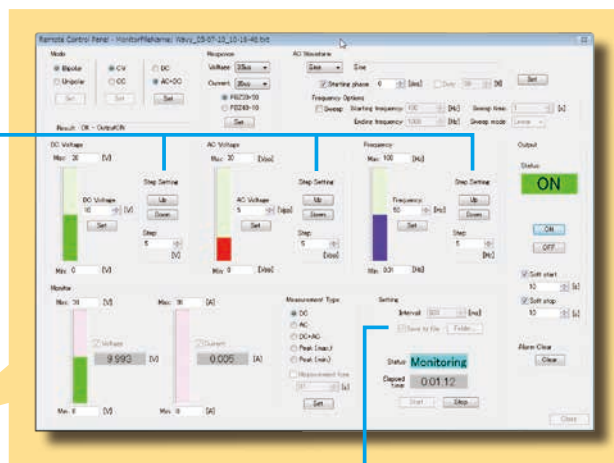

Time[s]	Current[A]	Voltage[V]	Power[W]
0.000	0.001	0.00	--
1.014	0.001	0.00	--
2.021	0.001	0.00	--
3.050	0.001	0.00	--
4.064	0.001	0.00	--
5.078	2.189	2.98	--
6.092	2.016	50.91	--
7.106	2.014	50.90	--

Output can be monitored and data stored as a text file in CSV or TSV format.

Example application of "Wavy" software – Voltage variation test for automotive equipment–

Replicate real waveforms with the PBZ series!

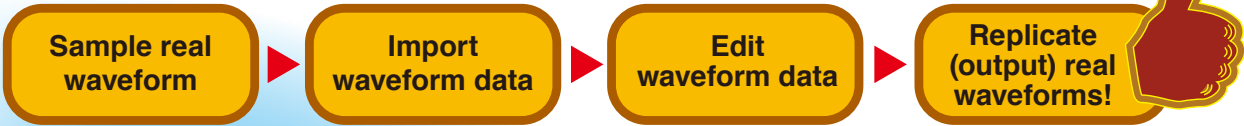

▼ Example of the creation of actual waveform reproduction program

1

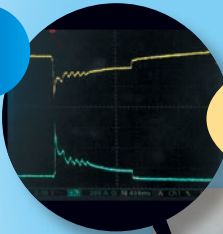

Sampling of the waveform with oscilloscope

First, capture real waveform data from the battery by connecting the probe to the battery terminal and starting the engine.

"Wavy" software will make an accurate reproduction of the real waveform.

2

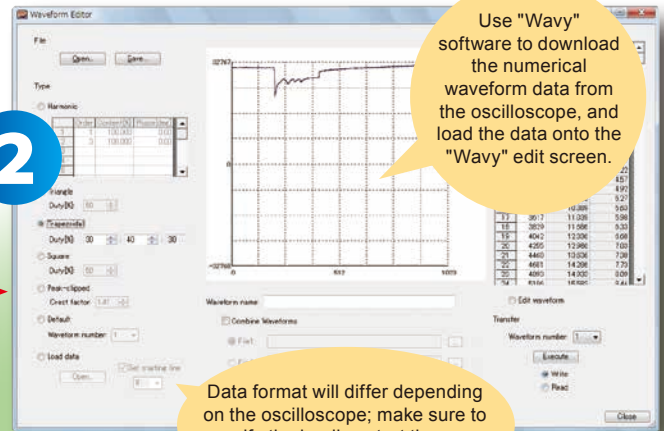

Use "Wavy" software to download the numerical waveform data from the oscilloscope, and load the data onto the "Wavy" edit screen.

Data format will differ depending on the oscilloscope; make sure to specify the loading start time, row and column as needed.

3

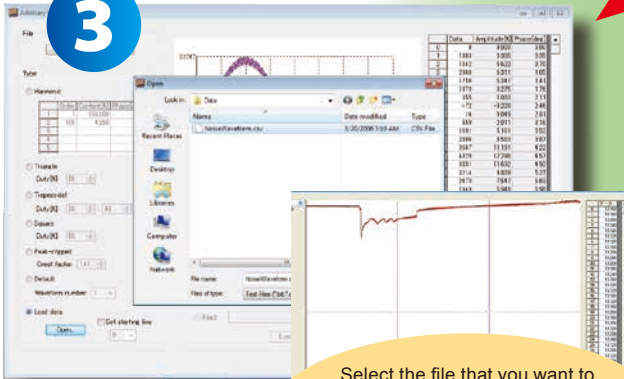

Select the file that you want to load. Specify your desired data range and convert the number of steps to a maximum of 1024 to be edited with "Wavy".

4

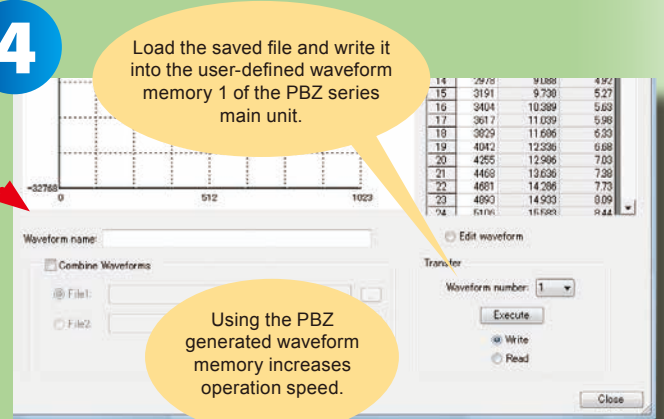

Load the saved file and write it into the user-defined waveform memory 1 of the PBZ series main unit.

Using the PBZ generated waveform memory increases operation speed.

5

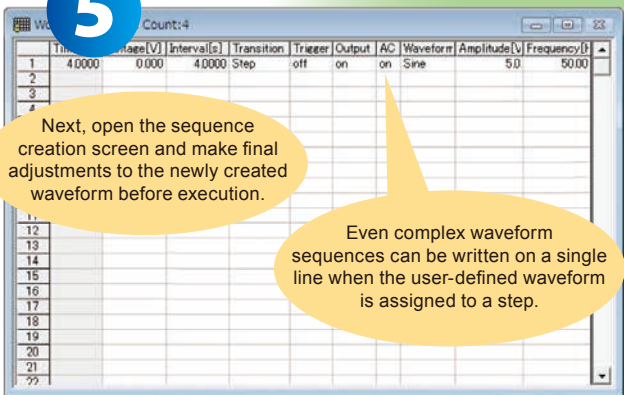

Next, open the sequence creation screen and make final adjustments to the newly created waveform before execution.

Even complex waveform sequences can be written on a single line when the user-defined waveform is assigned to a step.

6



Finally, transfer the sequence to program memory 1 of the PBZ unit. Initial settings are now complete.

Now let's reproduce the waveform!

Revolutionizing high power bipolar power supply system design! High power with fast response speeds



▲PBZ-SR Series

PBZ SR SERIES

PBZ20-60 SR	PBZ40-30 SR
PBZ20-80 SR	PBZ40-40 SR
PBZ20-100 SR	PBZ40-50 SR
PBZ60-20.1 SR	PBZ80-15 SR
PBZ60-26.8 SR	PBZ80-20 SR
PBZ60-33.5 SR	PBZ80-25 SR



●The PBZ SR is a series of high-power bipolar DC power supplies, building upon the revolutionary design of the original PBZ Intelligent Bipolar power supplies series. This series supports current up to ± 100 A and is assembled in an exclusive rack system (Smart Rack).

High Power Intelligent Bipolar Power Supply PBZ SR Series



PBZ BP SERIES

PBZ20-120 BP	PBZ40-60 BP
PBZ20-140 BP	PBZ40-70 BP
PBZ20-160 BP	PBZ40-80 BP
PBZ20-180 BP	PBZ40-90 BP
PBZ20-200 BP	PBZ40-100 BP

●The PBZ BP is a series of high-power bipolar DC power supplies, building upon the revolutionary design of the original PBZ Intelligent Bipolar power supplies series. This series supports current up to ± 200 A and is assembled in an exclusive rack system (Bipolar Pack).



▲PBZ-BP Series

High Power Intelligent Bipolar Power Supply PBZ BP Series



4-quadrant operation allows for both the sourcing and sinking of power, ideal for driving both inductive and capacitive loads. Also, the PBZ SR/BP is equipped with LAN, USB, GPIB and RS232C standard digital interfaces.

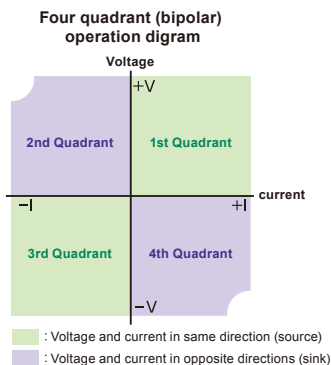

- User-defined waveform generation function
- Sequence function
- Synchronized operation function
- Central control with the master unit utilizing master and slave operation
- Displays the total output current of all units on the master unit (display of combined value) *1
- Safety design that switches all units off whenever the alarm is occurred on any unit of the system *2
- Guarantee of specifications with Smart Rack (test data standardly included)
- Equipped with LAN (Supports of LXI), USB, GPIB, and RS232C, as standard interface.



*1 Slave unit displays its own output current

*2 Clearing alarm for master unit clears alarms on all units.

Line-up

PBZ SR Series line-up

Available in a total of 12 models up to 2 kW maximum output with 4 output voltage types: ± 20 V, ± 40 V, ± 60 V, and ± 80 V.

Capacity Appearance	 Three parallel	 Four parallel	 Five parallel
20 V System	60 A	80 A	100 A
	PBZ20-60 SR	PBZ20-80 SR	PBZ20-100 SR
40 V System	30 A	40 A	50 A
	PBZ40-30 SR	PBZ40-40 SR	PBZ40-50 SR
60 V System	20.1 A	26.8 A	33.5 A
	PBZ60-20.1 SR	PBZ60-26.8 SR	PBZ60-33.5 SR
80 V System	15 A	20 A	25 A
	PBZ80-15 SR	PBZ80-20 SR	PBZ80-25 SR

PBZ BP Series line-up

Available in a total of 10 models up to 4kW maximum output with 2 output voltage types: ± 20 V, ± 40 V.

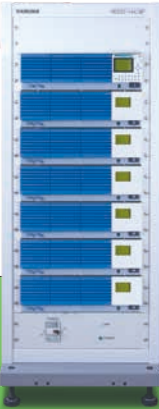
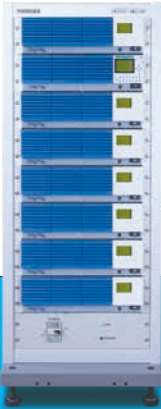
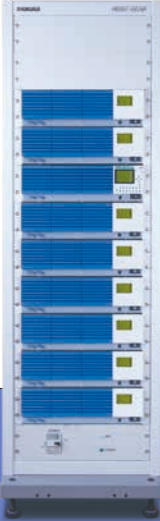
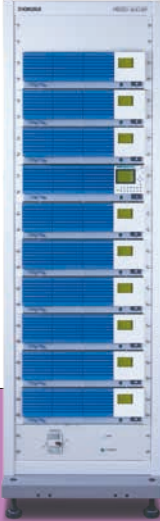
Capacity Appearance	 Six parallel	 Seven parallel	 Eight parallel	 Nine parallel	 Ten parallel
20 V System	120 A	140 A	160 A	180 A	200 A
	PBZ20-120 BP	PBZ20-140 BP	PBZ20-160 BP	PBZ20-180 BP	PBZ20-200 BP
40 V System	60 A	70 A	80 A	90 A	100 A
	PBZ40-60 BP	PBZ40-70 BP	PBZ40-80 BP	PBZ40-90 BP	PBZ40-100 BP

PBZ SR Series Specifications

Input / Output		PBZ20-60 SR	PBZ20-80 SR	PBZ20-100 SR	PBZ40-30 SR	PBZ40-40 SR	PBZ40-50 SR	
Input rating	Nominal input voltage	200 Vac to 240 Vac, single phase						
	Voltage range	180 Vac to 250 Vac						
	Frequency range	47 Hz to 63 Hz						
	Current	15 Aac or less	20 Aac or less	25 Aac or less	15 Aac or less	20 Aac or less	25 Aac or less	
	Inrush current	120 Apeak or less	160 Apeak or less	200 Apeak or less	120 Apeak or less	160 Apeak or less	200 Apeak or less	
	Power	2700 VA or less	3600 VA or less	4500 VA or less	2700 VA or less	3600 VA or less	4500 VA or less	
Output rating	Power factor	0.95 TYP (when the input voltage is 200 V)						
	Power	1200 W	1600 W	2000 W	1200 W	1600 W	2000 W	
	Voltage	± 20 V			± 40 V			
	Current	± 60 A	± 80 A	± 100 A	± 30 A	± 40 A	± 50 A	
Output terminal	Output terminal	Rear panel output terminals						
	Isolation voltage	500 Vdc Only the output's COM terminal can be grounded.						
Constant Voltage (CV)								
DC voltage	Settable range *1	Bipolar mode	0 V to ± (105 % of rating)					
		Unipolar mode	0 V to + (105 % of rating)					
		Fine feature	± 5 % of rating					
	Resolution	0.001 V (0.0001 V for the fine feature)						
	Accuracy *2	± (0.05 % of setting + 0.05 % of rating)						
Temperature coefficient	±100 ppm / °C of rating (TYP)							
AC voltage	Voltage	Settable range *1	0.00 Vpp to (210 % of rating) pp		0.00 Vpp to (210 % of rating) pp			
		Resolution	0.01 V			0.1 V		
		Accuracy *3	± 0.5 % of rating					
Frequency	Settable range	0.01 Hz to 100.00 kHz						
Constant voltage characteristics	Frequency response *4	DC to 100 kHz (-3 dB) (TYP)						
	Response *5 (TYP)	3.5 µs, 10 µs, 35 µs, 100 µs						
	Overshoot *6	5 % or less (TYP)						
	Ripple noise	(p-p) *7	30 mV (TYP)					
		(rms) *8	3 mV		6 mV			
	Load effect *9	± (0.005 % of setting + 1 mV)						
Source effect *10	± (0.005 % of setting + 1 mV)							
Constant current (CC)								
DC current	Settable range *1	Bipolar mode	0 A to ± (105 % of rating)					
		Unipolar mode	0 A to ± (105 % of rating)					
		Fine feature	± 5 % of rating					
	Resolution *11		0.003 A	0.004 A	0.005 A	0.003 A	0.004 A	0.005 A
		Fine feature *11	0.0003 A	0.0004 A	0.0005 A	0.0003 A	0.0004 A	0.0005 A
Accuracy *2	± 0.3 % of rating							
Temperature coefficient	± (100 ppm / °C of rating) (TYP)							
AC current	Current	Settable range *1	0 App to (210 % of rating) p-p					
		Resolution *12	0.03 A	0.04 A	0.05 A	0.03 A	0.04 A	0.05 A
		Accuracy *13	± 0.5 % of rating					
Frequency	Settable range	0.01 Hz to 100.00 kHz						
Constant current characteristics	Frequency response *14	DC to 10 kHz (-3 dB) (TYP)			DC to 5 kHz (-3 dB) (TYP)			
	Response *15 (TYP)	35 µs, 100 µs, 350 µs, 1 ms			70 µs, 100 µs, 350 µs, 1 ms			
	Overshoot *16	5 % or less (TYP)						
	Ripple noise (rms) *17	5 mA						
	Load effect *18	± (0.01 % of setting + 1 mA)						
Source effect *19	± (0.01 % of setting + 1 mA)							
AC common characteristics								
Frequency resolution		0.01 Hz						
Frequency Accuracy		± 200 ppm						
Sweep		Linear and logarithmic						
Waveform	Type	Sine wave, square wave, triangle wave, and 16 user-defined arbitrary waveforms						
	Start phase	0 to 359°						
	Square wave duty cycle	0.1 % to 99.9 % (f < 100 Hz), 1 % to 99 % (100 Hz ≤ f < 1 kHz), 10 % to 90 % (1 kHz ≤ f < 10 kHz), and fixed to 50 % (10 kHz ≤ f)						

*1: The peak value of the sum of the DC voltage and AC voltage is limited by the DC voltage's settable range.

*2: At an ambient temperature of 23 °C ±5 °C.

*3: 1 kHz sine wave, 3.5 µs response.

*4: A frequency where the amplitude ratio of the output voltage to the external signal input voltage is -3 dB (when the reference frequency is 1 kHz, the response is 3.5 µs, and when a rated load is connected).

*5: The rise or fall time (at rated load; excluding when output is turned on and off). The frequency response is based on the specified response setting (frequency bandwidth = 0.35/the rise time).

Rise time: The time it takes for the output voltage to rise from 10 % to 90 % of the rating when the output voltage is changed from 0 V to the rated voltage.

Fall time: The time it takes for the output current to fall from 90 % to 10 % of the rating when the output current is changed from the rated current to 0 A.

*6: Under no load or rated load.

*7: The measurement frequency bandwidth is 10 Hz to 20 MHz (at the output terminals).

*8: The measurement frequency bandwidth is 10 Hz to 1 MHz (at the output terminals).

*9: The change in the output voltage in response to a change in the output current from 0 % to 100 % of the current rating (measured at the sensing terminals when remote sensing is used).

*10: The change in the output voltage in response to a ±10 % change in the input voltage in reference to the nominal input voltage (measured at the sensing terminals when remote sensing is used).

*11: You can set the DC current in 0.001 A (0.0001 A for the fine feature) steps, but it may not change at this resolution depending on the relationship with the internal D/A resolution.

*12: You can set the AC current in 0.01 A steps, but it may not change at this resolution depending on the relationship with the internal D/A resolution.

[Conditions]

Condition in which the output COM terminal is connected to the chassis with the short piece (included) at the rear output terminal.
If not specified condition in which remote sensing is performed at output terminal.

Warm-up time is 30 minutes (condition with current flowing). Load is pure resistance. TYP value is typical value for 23°C, but performance is not guaranteed.

Input / Output		PBZ60-20.1 SR	PBZ60-26.8 SR	PBZ60-33.5 SR	PBZ80-15 SR	PBZ80-20 SR	PBZ80-25 SR
Input rating	Nominal input voltage	200 Vac to 240 Vac, single phase					
	Voltage range	180 Vac to 250 Vac					
	Frequency range	47 Hz to 63 Hz					
	Current	15 Aac or less	20 Aac or less	25 Aac or less	15 Aac or less	20 Aac or less	25 Aac or less
	Inrush current	120 Apeak or less	160 Apeak or less	200 Apeak or less	120 Apeak or less	160 Apeak or less	200 Apeak or less
	Power	2700 VA or less	3600 VA or less	4500 VA or less	2700 VA or less	3600 VA or less	4500 VA or less
	Power factor	0.95 TYP (when the input voltage is 200 V)					
Output rating	Power	1206 W	1608 W	2010 W	1200 W	1600 W	2000 W
	Voltage	± 60 V			± 80 V		
	Current	± 20.1 A	± 26.8 A	± 33.5 A	± 15 A	± 20 A	± 25 A
Output terminal	Output terminal	Rear panel output terminals					
	Isolation Voltage	500 Vdc Only the output's COM terminal can be grounded.					
Constant Voltage (CV)							
DC voltage	Settable range *1	Bipolar mode	0 V to ± (105 % of rating)				
		Unipolar mode	0 V to + (105 % of rating)				
		Fine feature	±5% of rating				
	Resolution	0.002 V (0.0002 V for the fine feature)					
	Accuracy *2	± (0.05 % of setting + 0.05 % of rating)					
AC voltage	Voltage	Temperature coefficient	± 100 ppm / °C of rating (TYP)				
		Settable range *1	0.0 Vpp to (210 % of rating) pp				
		Resolution	0.1 V				
	Accuracy *3	± 0.5 % of rating					
Frequency	Settable range	0.01 Hz to 100.00 kHz					
Constant voltage characteristics	Frequency response *4	DC to 100 kHz (-3 dB) (TYP)					
	Response *5 (TYP)	3.5 μs, 10 μs, 35 μs, 100 μs					
	Overshoot *6	5 % or less (TYP)					
	Ripple noise	(p-p) *7	40 mV (TYP)				
		(rms) *8	6 mV				
	Load effect *9	± (0.005 % of setting + 1 mV)					
Source effect *10	± (0.005 % of setting + 1 mV)						
Constant current (CC)							
DC current	Settable range *1	Bipolar mode	0 A to ± (105 % of rating)				
		Unipolar mode	0 A to ± (105 % of rating)				
		Fine feature	± 5 % of rating				
	Resolution *11	0.003 A	0.004 A	0.005 A	0.003 A	0.004 A	0.005 A
	Fine feature *11	0.0003 A	0.0004 A	0.0005 A	0.0003 A	0.0004 A	0.0005 A
Accuracy *2	± 0.3 % of rating						
AC current	Current	Temperature coefficient	± (100 ppm / °C of rating) (TYP)				
		Settable range *1	0 App to (210 % of rating) p-p				
		Resolution *12	0.03 A	0.04 A	0.05 A	0.03 A	0.04 A
	Accuracy *13	± 0.5 % of rating					
Frequency	Settable range	0.01 Hz to 100.00 kHz					
Constant current characteristics	Frequency response *14	DC to 10 kHz (-3 dB) (TYP)					
	Response *15 (TYP)	35 μs, 100 μs, 350 μs, 1 ms					
	Overshoot *16	5 % or less (TYP)					
	Ripple noise (rms) *17	5 mA					
	Load effect *18	± (0.01 % of setting + 1 mA)					
Source effect *19	± (0.01 % of setting + 1 mA)						
AC common characteristics							
Frequency resolution		0.01 Hz					
Frequency Accuracy		± 200 ppm					
Sweep		Linear and logarithmic					
Waveform	Type	Sine wave, square wave, triangle wave, and 16 user-defined arbitrary waveforms					
	Start phase	0 to 359°					
	Square wave duty cycle	0.1 % to 99.9 % (f < 100 Hz), 1 % to 99 % (100 Hz ≤ f < 1 kHz), 10 % to 90 % (1 kHz ≤ f < 10 kHz), and fixed to 50 % (10 kHz ≤ f)					

*13: 100 Hz sine wave, 35 μs/70 μs response, and shorted output.

*14: A frequency where the amplitude ratio of the output current to the external signal input voltage is -3 dB (when the reference frequency is 100 Hz, the response is 35 μs/75 μs, and a rated load is connected). The frequency response changes according to the load impedance. When the load impedance increases, the frequency response decreases.

*15: The rise or fall time (at rated load; excluding when output is turned on and off). The rise and fall times change according to the load impedance.
Rise time: The time it takes for the output current to rise from 10 % to 90 % of the rating when the output current is changed from 0 A to the rated current.
Fall time: The time it takes for the output current to fall from 90 % to 10 % of the rating when the output current is changed from the rated current to 0 A.

*16: Under short circuit or rated load.

*17: The measurement frequency bandwidth is 10 Hz to 1 MHz (when the output voltage is in the range of 10 % to 100 % of the rated output voltage).

*18: The change in the output current in response to a change in the output voltage from 10 % to 100 % of the voltage rating.

*19: The change in the output current in response to a ±10 % change in the input voltage in reference to the nominal input voltage (when the output voltage is in the range of 10 % to 100 % of the voltage rating).

Measurement function		PBZ20-60 SR	PBZ20-80 SR	PBZ20-100 SR	PBZ40-30 SR	PBZ40-40 SR	PBZ40-50 SR
Voltage measurement (DC)	Measurement range	120 % of rating					
	Resolution	0.001 V					
	Accuracy *1	± (0.05 % of reading + 0.05 % of rating)					
Voltage measurement (AC and DC + AC)	Measurement range	AC	120 % of rating / CF				
		DC + AC	120 % of rating				
	Resolution	0.001 V					
	Accuracy *1, *2	±(0.5 % of reading + 0.1 % of rating) in the range of 5 Hz to 10 kHz ±(1 % of reading + 0.2 % of rating) in the range of 10 kHz to 50 kHz ±(2 % of reading + 0.2 % of rating) in the range of 50 kHz to 100 kHz					
Voltage measurement (PEAK)	Measurement range	120 % of rating					
	Resolution	0.01 V					
	Accuracy *1, *3	± 0.5 % of rating					
Current measurement (DC)	Measurement range	120 % of rating					
	Resolution	0.003 A	0.004 A	0.005 A	0.003 A	0.004 A	0.005 A
	Accuracy *1	± (0.3 % of reading + 0.7 % of rating)	± (0.3 % of reading + 1.0 % of rating)	± (0.3 % of reading + 1.3 % of rating)	± (0.3 % of reading + 0.7 % of rating)	± (0.3 % of reading + 1.0 % of rating)	± (0.3 % of reading + 1.3 % of rating)
	Temperature coefficient	± (150 ppm / °C of rating) (TYP)					
Current measurement (AC, DC + AC)	Measurement range	AC	120 % of rating / CF				
		DC + AC	120 % of rating				
	Resolution	0.003A	0.004 A	0.005 A	0.003 A	0.004 A	0.005 A
	Accuracy *1, *2	±(3 % of reading + 0.1 % of rating) (5 Hz to 10 kHz) ±(10 % of reading + 1 % of rating) (10 kHz to 100 kHz)					
Current measurement (PEAK)	Measurement range	120 % of rating					
	Resolution	0.03 A	0.04 A	0.05 A	0.03 A	0.04 A	0.05 A
	Accuracy *1, *3	± 0.5 % of rating					
Measurement time (Aperture)	100 µs to 3600 s						
Protection Features							
Overvoltage protection, Overcurrent protection, Overheat protection, Power limit (sink power)							
Interface							
RS232C, GPIB, USB, LAN							
General							
Operating temperature range		0 °C to +40 °C (+32 °F to +104 °F)					
Operating humidity range		20 %rh to 85 %rh (no condensation)					
Storage temperature range		-25 °C to +70 °C (-13 °F to +158 °F)					
Storage humidity range		90 %rh or less (no condensation)					
Insulation resistance	Across the primary circuit and the output terminals	500 Vdc, 30 MΩ or greater (at 70 %rh humidity or less)					
	Across the primary circuit and chassis						
	Across the output terminals and chassis *4	500 Vdc, 0.33 MΩ or greater	500 Vdc, 0.25 MΩ or greater	500 Vdc, 0.20 MΩ or greater	500 Vdc, 0.33 MΩ or greater	500 Vdc, 0.25 MΩ or greater	500 Vdc, 0.20 MΩ or greater
Withstand voltage	Across the primary circuit and the output terminals	No abnormalities at 1500 Vac for 1 minute					
	Across the primary circuit and chassis						
Leakage current (250 V / 60 Hz)		10 mA or less					
Earth continuity		100 Aac, 0.1 Ω or less					
Cooling method		Forced air cooling using variable-speed, heat-sensitive fan					
Battery backup		Settings are retained when the power is off. At least three years of battery life (at 25 °C).					
Weight		Approx. 110 kg (242.51 lbs)	Approx. 130 kg (286.60 lbs)	Approx. 160 kg (352.74 lbs)	Approx. 110 kg (242.51 lbs)	Approx. 130 kg (286.60 lbs)	Approx. 160 kg (352.74 lbs)
Dimensions (maximum)		432.6(17.03"*) (545(21.46"*))W× 579.4(22.81"*) (685(26.97"*))H× 700(27.56"*) (735(28.94"*))D mm (inches)	432.6(17.03"*) (545(21.46"*))W× 712.1(28.04"*) (815(32.09"*))H× 700(27.56"*) (735(28.94"*))D mm (inches)	432.6(17.03"*) (545(21.46"*))W× 844.8(33.26"*) (950(37.40"*))H× 700(27.56"*) (735(28.94"*))D mm (inches)	432.6(17.03"*) (545(21.46"*))W× 579.4(22.81"*) (685(26.97"*))H× 700(27.56"*) (735(28.94"*))D mm (inches)	432.6(17.03"*) (545(21.46"*))W× 712.1(28.04"*) (815(32.09"*))H× 700(27.56"*) (735(28.94"*))D mm (inches)	432.6(17.03"*) (545(21.46"*))W× 844.8(33.26"*) (950(37.40"*))H× 700(27.56"*) (735(28.94"*))D mm (inches)
Accessories		PBZ-SR series manuals: Setup Guide (1 pc.), Quick Reference (Japanese: 1 pc / English: 1 pc.), Safety Information (1 pc.) J1 connector kit: Socket (1 pc.), Protection covers (2 pairs), Pins (30 pc.) Heavy object warning label (1 pc.), CD-ROM (1 pc.)					

*1: At an ambient temperature of 23 °C ± 5 °C.

*2: When the input signal is in the 100 kHz bandwidth and has a crest factor of 3 or less (the measurement time is at least 10 times the input signal period).

*3: Calibrated with a 1 kHz sine wave.

*4: At 70 %rh humidity or less

[Conditions]

Condition in which the output COM terminal is connected to the chassis with the short piece (included) at the rear output terminal.

If not specified, condition in which remote sensing is performed at output terminal.

Warm-up time is 30 minutes (condition with current flowing). Load is pure resistance. TYP value is typical value for 23°C, but performance is not guaranteed.

Measurement function		PBZ60-20.1 SR	PBZ60-26.8 SR	PBZ60-33.5 SR	PBZ80-15 SR	PBZ80-20 SR	PBZ80-25 SR
Voltage measurement (DC)	Measurement range	120 % of rating					
	Resolution	0.001 V					
	Accuracy *1	± (0.05 % of reading + 0.05 % of rating)					
Voltage measurement (AC and DC + AC)	Measurement range	AC	120 % of rating / CF				
		DC + AC	120 % of rating				
	Resolution	0.001 V					
	Accuracy *1, *2	±(0.5 % of reading + 0.1 % of rating) in the range of 5 Hz to 10 kHz ±(1 % of reading + 0.2 % of rating) in the range of 10 kHz to 50 kHz ±(2 % of reading + 0.2 % of rating) in the range of 50 kHz to 100 kHz					
Voltage measurement (PEAK)	Measurement range	120 % of rating					
	Resolution	0.01 V					
	Accuracy *1, *3	± 0.5 % of rating					
Current measurement (DC)	Measurement range	120 % of rating					
	Resolution	0.003 A	0.004 A	0.005 A	0.003 A	0.004 A	0.005 A
	Accuracy *1	± (0.3 % of reading + 0.7 % of rating)	± (0.3 % of reading + 1.0 % of rating)	± (0.3 % of reading + 1.3 % of rating)	± (0.3 % of reading + 0.7 % of rating)	± (0.3 % of reading + 1.0 % of rating)	± (0.3 % of reading + 1.3 % of rating)
	Temperature coefficient	± (150 ppm / °C of rating) (TYP)					
Current measurement (AC and DC + AC)	Measurement range	AC	120 % of rating / CF				
		DC + AC	120 % of rating				
	Resolution	0.003A	0.004 A	0.005 A	0.003 A	0.004 A	0.005 A
	Accuracy *1,*2	± (3 % of reading + 0.1 % of rating) ± (10 % of reading + 1 % of rating)					
Current measurement (PEAK)	Measurement range	120 % of rating					
	Resolution	0.03 A	0.04 A	0.05 A	0.03 A	0.04 A	0.05 A
	Accuracy *1,*3	± 0.5 % of rating					
Measurement time (Aperture)	100 µs to 3600 s						
Protection Features							
Overvoltage protection, Overcurrent protection, Overheat protection, Power limit (sink power)							
Interface							
RS232C, GPIB, USB, LAN							
General							
Operating temperature range		0 °C to 40 °C					
Operating humidity range		20 %RH to 85 %RH (no condensation)					
Storage temperature range		-25 °C to 70 °C					
Storage humidity range		90 %rh or less (no condensation)					
Insulation resistance	Across the primary circuit and the output terminals	500 Vdc, 30 MΩ or greater (at 70 %rh humidity or less)					
	Across the primary circuit and chassis						
	Across the output terminals and chassis *4	500 Vdc, 0.33 MΩ or greater	500 Vdc, 0.25 MΩ or greater	500 Vdc, 0.20 MΩ or greater	500 Vdc, 0.33 MΩ or greater	500 Vdc, 0.25 MΩ or greater	500 Vdc, 0.20 MΩ or greater
Withstand voltage	Across the primary circuit and the output terminals	No abnormalities at 1500 Vac for 1 minute					
	Across the primary circuit and chassis						
Leakage current (250 V / 60 Hz)		10 mA or less					
Earth continuity		100 Aac, 0.1 Ω or less					
Cooling method		Forced air cooling using variable-speed, heat-sensitive fan					
Battery backup		Settings are retained when the power is off. At least three years of battery life (at 25 °C).					
Weight		Approx. 110 kg (242.51 lbs)	Approx. 130 kg (286.60 lbs)	Approx. 160 kg (352.74 lbs)	Approx. 110 kg (242.51 lbs)	Approx. 130 kg (286.60 lbs)	Approx. 160 kg (352.74 lbs)
Dimensions (maximum)		432.6(17.03*)(545(21.46*))W× 579.4(22.81*)(685(26.97*))H× 700(27.56*)(735(28.94*))D mm (inches)	432.6(17.03*)(545(21.46*))W× 712.1(28.04*)(815(32.09*))H× 700(27.56*)(735(28.94*))D mm (inches)	432.6(17.03*)(545(21.46*))W× 844.8(33.26*)(950(37.40*))H× 700(27.56*)(735(28.94*))D mm (inches)	432.6(17.03*)(545(21.46*))W× 579.4(22.81*)(685(26.97*))H× 700(27.56*)(735(28.94*))D mm (inches)	432.6(17.03*)(545(21.46*))W× 712.1(28.04*)(815(32.09*))H× 700(27.56*)(735(28.94*))D mm (inches)	432.6(17.03*)(545(21.46*))W× 844.8(33.26*)(950(37.40*))H× 700(27.56*)(735(28.94*))D mm (inches)
Accessories		PBZ-SR series manuals: Setup Guide (1 pc.), Quick Reference (Japanese: 1 pc / English: 1 pc.), Safety Information (1 pc.) J1 connector kit: Socket (1 pc.), Protection covers (2 pairs), Pins (30 pc.) Heavy object warning label (1 pc.), CD-ROM (1 pc.)					

*1: At an ambient temperature of 23 °C ± 5 °C.

*2: When the input signal is in the 100 kHz bandwidth and has a crest factor of 3 or less (the measurement time is at least 10 times the input signal period).

*3: Calibrated with a 1 kHz sine wave.

*4: At 70 %rh humidity or less

PBZ BP Series Specifications

Input / Output		PBZ20-120 BP	PBZ20-140 BP	PBZ20-160 BP	PBZ20-180 BP	PBZ20-200 BP	
Input rating	Nominal input voltage	200 Vac to 240 Vac, single phase				200 Vac, single phase	
	Voltage range	180 Vac to 250 Vac				180 Vac to 220 Vac	
	Frequency range	47 Hz to 63 Hz					
	Current	30 Aac or less	35 Aac or less	40 Aac or less	45 Aac or less	50 Aac or less	
	Inrush current	240 Apeak or less	280 Apeak or less	320 Apeak or less	360 Apeak or less	400 Apeak or less	
	Power	5400 VA or less	6300 VA or less	7200 VA or less	8100 VA or less	9000 VA or less	
	Power factor	0.95 TYP (when the input voltage is 200 V)					
Output rating	Power	2400 W	2800 W	3200 W	3600 W	4000 W	
	Voltage	± 20 V					
	Current	± 120 A	± 140 A	± 160 A	± 180 A	± 200 A	
Output terminal	Output terminal	Rear-panel output terminals (OUTPUT1, OUTPUT2)					
	Isolation voltage	300 Vdc Only the output's COM terminal can be grounded.					
Constant Voltage (CV)							
DC voltage	Setting range *1	Bipolar mode	0 V to ± (105 % of rating)				
		Unipolar mode	0 V to + (105 % of rating)				
		Fine feature	±5 % of rating				
	Resolution	0.001 V (0.0001 V for the fine feature)					
	Setting accuracy *2	± (0.05 % of setting + 0.05 % of rating)					
Temperature coefficient	± 100 ppm / °C of rating (TYP)						
AC voltage	Voltage	Setting range *1	0.00 Vp-p to (210 % of rating) p-p				
		Resolution	0.1 V				
		Accuracy *3	± 0.5% of rating				
Frequency	Setting range	0.01 Hz to 100.00 kHz					
Constant voltage characteristics	Frequency response *4	DC to 80 kHz (-3 dB) (TYP)					
	Response *5 (TYP)	3.5 μs, 10 μs, 35 μs, 100 μs					
	Overshoot *6	5 % or less (TYP)					
	Ripple noise	(p-p)	50 mV (TYP)				
		(rms)	6 mV				
Load regulation *7	± (0.005 % of setting + 1 mV)						
Line regulation *8	± (0.005 % of setting + 1 mV)						
Constant current (CC)							
DC current	Setting range *1	Bipolar mode	0 A to ± (105 % of rating)				
		Unipolar mode	0 A to ± (105 % of rating)				
		Fine feature	± 5 % of rating				
	Resolution *9		0.006 A	0.007 A	0.008 A	0.009 A	0.010 A
		Fine feature	0.0006 A	0.0007 A	0.0008 A	0.0009 A	0.0010 A
Setting accuracy *2	± 0.5 % of rating						
Temperature coefficient	± (100 ppm / °C of rating) (TYP)						
AC current	Current	Setting range *1	0 Ap-p to (210 % of rating) p-p				
		Resolution *9	0.06 A	0.07 A	0.08 A	0.09 A	0.10 A
		Accuracy *10	± 0.5 % of rating				
Frequency	Setting range	0.01 Hz to 100.00 kHz					
Constant current characteristics	Frequency response *11	DC to 8 kHz (-3 dB) (TYP)					
	Response *12 (TYP)	35 μs, 100 μs, 350 μs, 1 ms					
	Overshoot *13	5 % or less (TYP)					
	Ripple noise (rms)	10 mA					
	Load regulation *14	± (0.01 % of setting + 1 mA)					
Line regulation *15	± (0.01 % of setting + 1 mA)						
AC common characteristics							
Frequency resolution		0.01 Hz					
Frequency Accuracy		± 200 ppm					
Sweep		Linear and logarithmic					
Waveform	Type	Sine wave, square wave, triangle wave, and 16 user-defined arbitrary waveforms					
	Start phase	0 to 359°					
	Square wave duty cycle	0.1 % to 99.9 % (f < 100 Hz), 1 % to 99 % (100 Hz ≤ f < 1 kHz), 10 % to 90 % (1 kHz ≤ f < 10 kHz), and fixed to 50 % (10 kHz ≤ f)					

*1: The peak value of the sum of the DC voltage and AC voltage is limited by the DC voltage's settable range.

*2: At an ambient temperature of 23 °C±5 °C.

*3: 100 Hz sine wave, response 10 μs. Under no load.

*4: A frequency where the amplitude ratio of the output voltage to the external signal input voltage is -3 dB (when the reference frequency is 1 kHz sine wave, the response is 3.5 μs, when the OUTPUT1 terminals are used, and when a rated load is connected).

*5: The rise or fall time (at rated load; excluding when output is turned on and off). The frequency response is based on the specified response setting (frequency bandwidth = 0.35/the rise time).

Rise time: The time it takes for the output voltage to rise from 10 % to 90 % of the rating when the output voltage is changed from 0 V to the rated voltage.

Fall time: The time it takes for the output voltage to fall from 90 % to 10 % of the rating when the output voltage is changed from the rated voltage to 0 V.

*6: Under no load or rated load.

*7: The change in the output voltage in response to a fluctuation in the output current from 0 % to 100 % of the output current rating (measured at the sensing terminals when remote sensing is used).

*8: The change in the output voltage in response to a ±10 % fluctuation in the input voltage in reference to the nominal input voltage (measured at the sensing terminals when remote sensing is used).

*9: The display resolution and the actual resolution are different. The display resolution of DC current is 0.001 A, but the actual resolution is 0.006 A. (When the fine feature is in use, the display resolution is 0.000 1 A, but the actual resolution is 0.000 6 A). The display resolution of AC current and the actual resolution are 0.1 A. The display resolution of overcurrent protection is 0.1 A, but the actual resolution is 0.6 A.

[Conditions]

Condition in which the output COM terminal is connected to the chassis with the short piece (included) at the rear output terminal.

If not specified, condition in which remote sensing is performed at output terminal.

Warm-up time is 30 minutes (condition with current flowing). Load is pure resistance. TYP value is typical value for 23°C, but performance is not guaranteed.

Input / Output		PBZ40-60 BP	PBZ40-70 BP	PBZ40-80 BP	PBZ40-90 BP	PBZ40-100 BP	
Input rating	Nominal input voltage	200 Vac to 240 Vac, single phase				200 Vac, single phase	
	Voltage range	180 Vac to 250 Vac				180 Vac to 220 Vac	
	Frequency range	47 Hz to 63 Hz					
	Current	30 Aac or less	35 Aac or less	40 Aac or less	45 Aac or less	50 Aac or less	
	Inrush current	240 Apeak or less	280 Apeak or less	320 Apeak or less	360 Apeak or less	400 Apeak or less	
	Power	5400 VA or less	6300 VA or less	7200 VA or less	8100 VA or less	9000 VA or less	
	Power factor	0.95 TYP (when the input voltage is 200 V)					
Output rating	Power	2400 W	2800 W	3200 W	3600 W	4000 W	
	Voltage	± 40 V					
	Current	± 60 A	± 70 A	± 80 A	± 90 A	± 100 A	
Output terminal	Output terminal	Rear panel output terminals					
	Isolation voltage	300 Vdc Only the output's COM terminal can be grounded.					
Constant Voltage (CV)							
DC voltage	Setting range *1	Bipolar mode	0 V to ± (105 % of rating)				
		Unipolar mode	0 V to + (105 % of rating)				
		Fine feature	± 5% of rating				
	Resolution	0.001 V (0.0001 V for the fine feature)					
	Setting accuracy *2	± (0.05 % of setting + 0.05 % of rating)					
AC voltage	Voltage	Temperature coefficient	± 100 ppm / °C of rating (TYP)				
		Setting range *1	0.00 Vp-p to (210 % of rating) p-p				
		Resolution	0.1 V				
	Accuracy *3	± 0.5% of rating					
Frequency	Setting range	0.01 Hz to 100.00 kHz					
Constant voltage characteristics	Frequency response *4	DC to 80 kHz (-3 dB) (TYP)					
	Response *5 (TYP)	3.5 μs, 10 μs, 35 μs, 100 μs					
	Overshoot *6	5 % or less (TYP)					
	Ripple noise	(p-p)	50 mV (TYP)				
		(rms)	12 mV				
	Load regulation *7	± (0.005 % of setting + 1 mV)					
Line regulation *8	± (0.005 % of setting + 1 mV)						
Constant current (CC)							
DC current	Setting range *1	Bipolar mode	0 A to ± (105 % of rating)				
		Unipolar mode	0 A to ± (105 % of rating)				
		Fine feature	± 5 % of rating				
	Resolution *9	0.006 A	0.007 A	0.008 A	0.009 A	0.010 A	
	Fine feature	0.0006 A	0.0007 A	0.0008 A	0.0009 A	0.0010 A	
Setting accuracy *2	± 0.3 % of rating						
Temperature coefficient	± (100 ppm / °C of rating) (TYP)						
AC current	Current	Setting range *1	0 Ap-p to (210 % of rating) p-p				
		Resolution *9	0.06 A	0.07 A	0.08 A	0.09 A	0.10 A
		Accuracy *10	± 0.5 % of rating				
Frequency	Setting range	0.01 Hz to 100.00 kHz					
Constant current characteristics	Frequency response *11	DC to 4 kHz (-3 dB) (TYP)					
	Response *12 (TYP)	70 μs, 100 μs, 350 μs, 1 ms					
	Overshoot *13	5 % or less (TYP)					
	Ripple noise (rms)	10 mA					
	Load regulation *14	± (0.01 % of setting + 1 mA)					
Line regulation *15	± (0.01 % of setting + 1 mA)						
AC common characteristics							
Frequency resolution		0.01 Hz					
Frequency Accuracy		± 200 ppm					
Sweep		Linear and logarithmic					
Waveform	Type	Sine wave, square wave, triangle wave, and 16 user-defined arbitrary waveforms					
	Start phase	0 to 359°					
	Square wave duty cycle	0.1 % to 99.9 % (f < 100 Hz), 1 % to 99 % (100 Hz ≤ f < 1 kHz), 10 % to 90 % (1 kHz ≤ f < 10 kHz), and fixed to 50 % (10 kHz ≤ f)					

*10: With a 100 Hz sine wave, 35 μs response, and shorted output.

*11: A frequency where the ratio of the output current amplitude to the external signal input voltage amplitude is -3 dB (when the reference frequency is 100 Hz, the response is 35 μs, and when a rated load is connected). The frequency response change according to the load impedance. Frequency response decreases when the load impedance increases.

*12: The rise or fall time (at rated load; excluding when output is turned on and off). The rise and fall times change according to the load impedance.

Rise time: The time it takes for the output current to rise from 10 % to 90 % of the rating when the output current is changed from 0 A to the rated current.

Fall time: The time it takes for the output current to fall from 90 % to 10 % of the rating when the output current is changed from the rated current to 0 A.

*13: Under short circuit or rated load.

*14: The change in the output current in response to a change in the output voltage from 10 % to 100 % of the rated output voltage.

*15: The change in the output current in response to a ±10 % fluctuation in the input voltage in reference to the nominal input voltage (when the output voltage is in the range of 10 % to 100 % of the rating).

Measurement function		PBZ20-120 BP	PBZ20-140 BP	PBZ20-160 BP	PBZ20-180 BP	PBZ20-200 BP
Voltage measurement (DC)	Measurement range	120 % of rating				
	Resolution	0.001 V				
	Accuracy *1	± (0.05 % of reading + 0.05 % of rating)				
Voltage measurement (AC and DC + AC)	Measurement range	AC	120 % of rating / CF			
		DC + AC	120 % of rating			
	Resolution	0.001 V				
	Accuracy *1, *2	±(0.5 % of reading + 0.1 % of rating) (5 Hz to 10 kHz)				
±(1 % of reading + 0.2 % of rating) (10 kHz to 50 kHz)						
±(2 % of reading + 0.2 % of rating) (50 kHz to 100 kHz)						
Voltage measurement (PEAK)	Measurement range	120 % of rating				
	Resolution	0.01 V				
	Accuracy *1, *3	± 0.5 % of rating				
Current measurement (DC)	Measurement range	120 % of rating				
	Resolution	0.006 A	0.007 A	0.008 A	0.009 A	0.010 A
	Accuracy *1	± (0.3 % of reading + 1.6 % of rating)	± (0.3 % of reading + 1.9 % of rating)	± (0.3 % of reading + 2.2 % of rating)	± (0.3 % of reading + 2.5 % of rating)	± (0.3 % of reading + 2.8 % of rating)
	Temperature coefficient	± (150 ppm / °C of rating) (TYP)				
Current measurement (AC and DC + AC)	Measurement range	AC	120 % of rating / CF			
		DC + AC	120 % of rating			
	Resolution	0.006 A	0.007 A	0.008 A	0.009 A	0.010 A
	Accuracy *1, *2	±(3 % of reading + 0.1 % of rating) (5 Hz to 10 kHz)				
±(10 % of reading + 1 % of rating) (10 kHz to 100 kHz)						
Current measurement (PEAK)	Measurement range	120 % of rating				
	Resolution	0.06 A	0.07 A	0.08 A	0.09 A	0.10 A
	Accuracy *1, *3	± 0.5 % of rating				
Measurement time (Aperture)	100 µs to 3600 s					
Protection Features						
Overvoltage protection, Overcurrent protection, Overheat protection, Power limit (sink power)						
Interface						
RS232C, GPIB, USB, LAN						
General						
Operating temperature range		0 °C to 40 °C (32 °F to 104 °F)				
Operating humidity range		20 %rh to 85 %rh (no condensation)				
Storage temperature range		-25 °C to 70 °C (-13 °F to 158 °F)				
Storage humidity range		90 %rh or less (no condensation)				
Insulation resistance *4	Between the primary circuit and chassis	500 Vdc, 30 MΩ or more				
	Between the primary circuit and the output terminals					
	Between the output terminals and chassis	300 Vdc, 0.17 MΩ or more	300 Vdc, 0.14 MΩ or more	300 Vdc, 0.13 MΩ or more	300 Vdc, 0.11 MΩ or more	300 Vdc, 0.1 MΩ or more
Withstand voltage	Between the primary circuit and chassis	No abnormalities at 1500 Vac for 1 minute				
	Between the primary circuit and the output terminals					
Leakage current (250 V, 60 Hz) *5		10 mA or less				
Earth continuity		100 Aac, 0.1 Ω or less				
Cooling method		Forced air cooling using variable-speed, heat-sensitive fan				
Battery backup		Settings are retained when the power is off. At least three years of battery life (at 25 °C).				
Weight		Approx. 265 kg (584.2 lbs)	Approx. 290 kg (639.3 lbs)	Approx. 310 kg (683.4 lbs)	Approx. 350 kg (771.6 lbs)	Approx. 370 kg (815.7 lbs)
Dimensions		570(22.44") W× 1350(53.15") H× 950(37.40") Dmm (inches)	570(22.44") W× 1350(53.15") H× 950(37.40") Dmm (inches)	570(22.44") W× 1350(53.15") H× 950(37.40") Dmm (inches)	570(22.44") W× 1750(68.90") H× 950(37.40") Dmm (inches)	570(22.44") W× 1750(68.90") H× 950(37.40") Dmm (inches)
Accessories		PBZ-BP series manuals: Setup Guide (1 pc.), Quick Reference (Japanese: 1 pc / English: 1 pc.), Safety Information (1 pc.) J1 connector kit: Socket (1 pc.), Protection covers (2 pairs), Pins (30 pc.) Heavy object warning label (1 pc.), CD-ROM (1 pc.)				

*1: At an ambient temperature of 23 °C ±5 °C.

*2: When the input signal is in the 100 kHz bandwidth and has a crest factor of 3 or less (the measurement time is at least 10 times the input signal period).

*3: Calibrated with a 1 kHz sine wave.

*4: At 70 %rh humidity or less

*5: At 200 V, 60 Hz for PBZ20-200BP

[Conditions]

Condition in which the output COM terminal is connected to the chassis with the short piece (included) at the rear output terminal.

If not specified, condition in which remote sensing is performed at output terminal.

Warm-up time is 30 minutes (condition with current flowing). Load is pure resistance. TYP value is typical value for 23°C, but performance is not guaranteed.

Measurement function		PBZ40-60 BP	PBZ40-70 BP	PBZ40-80 BP	PBZ40-90 BP	PBZ40-100 BP
Voltage measurement (DC)	Measurement range	120 % of rating				
	Resolution	0.001 V				
	Accuracy *1	± (0.05 % of reading + 0.05 % of rating)				
Voltage measurement (AC and DC + AC)	Measurement range	AC	120 % of rating / CF			
		DC + AC	120 % of rating			
	Resolution	0.001 V				
	Accuracy *1, *2	±(0.5 % of reading + 0.1 % of rating) (5 Hz to 10 kHz)				
±(1 % of reading + 0.2 % of rating) (10 kHz to 50 kHz)						
±(2 % of reading + 0.2 % of rating) (50 kHz to 100 kHz)						
Voltage measurement (PEAK)	Measurement range	120 % of rating				
	Resolution	0.01 V				
	Accuracy *1, *3	± 0.5 % of rating				
Current measurement (DC)	Measurement range	120 % of rating				
	Resolution	0.006 A	0.007 A	0.008 A	0.009 A	0.010 A
	Accuracy *1	± (0.3 % of reading + 1.6 % of rating)	± (0.3 % of reading + 1.9 % of rating)	± (0.3 % of reading + 2.2 % of rating)	± (0.3 % of reading + 2.5 % of rating)	± (0.3 % of reading + 2.8 % of rating)
	Temperature coefficient	± (150 ppm / °C of rating) (TYP)				
Current measurement (AC and DC + AC)	Measurement range	AC	120 % of rating / CF			
		DC + AC	120 % of rating			
	Resolution	0.006 A	0.007 A	0.008 A	0.009 A	0.010 A
	Accuracy *1, *2	±(3 % of reading + 0.1 % of rating) (5 Hz to 10 kHz)				
±(10 % of reading + 1 % of rating) (10 kHz to 100 kHz)						
Current measurement (PEAK)	Measurement range	120 % of rating				
	Resolution	0.06 A	0.07 A	0.08 A	0.09 A	0.10 A
	Accuracy *1, *3	± 0.5 % of rating				
Measurement time (Aperture)	100 µs to 3600 s					
Protection Features						
Overvoltage protection, Overcurrent protection, Overheat protection, Power limit (sink power)						
Interface						
RS232C, GPIB, USB, LAN						
General						
Operating temperature range		0 °C to 40 °C (32 °F to 104 °F)				
Operating humidity range		20 %rh to 85 %rh (no condensation)				
Storage temperature range		-25 °C to 70 °C (-13 °F to 158 °F)				
Storage humidity range		90 %rh or less (no condensation)				
Insulation resistance *4	Between the primary circuit and chassis	500 Vdc, 30 MΩ or more				
	Between the primary circuit and the output terminals					
	Between the output terminals and chassis	300 Vdc, 0.17 MΩ or more	300 Vdc, 0.14 MΩ or more	300 Vdc, 0.13 MΩ or more	300 Vdc, 0.11 MΩ or more	300 Vdc, 0.1 MΩ or more
Withstand voltage	Between the primary circuit and chassis	No abnormalities at 1500 Vac for 1 minute				
	Between the primary circuit and the output terminals					
Leakage current (250 V, 60 Hz) *5		15 mA or less				
Earth continuity		100 Aac, 0.1 Ω or less				
Cooling method		Forced air cooling using variable-speed, heat-sensitive fan				
Battery backup		Settings are retained when the power is off. At least three years of battery life (at 25 °C).				
Weight		Approx. 255kg (562.18 lbs)	Approx. 280 kg (617.29 lbs)	Approx. 300 kg (661.39 lbs)	Approx. 340 kg (749.57 lbs)	Approx. 360 kg (793.66 lbs)
Dimensions		570(22.44") W× 1350(53.15")H× 950(37.40")Dmm (inches)	570(22.44") W× 1350(53.15")H× 950(37.40")Dmm (inches)	570(22.44") W× 1350(53.15")H× 950(37.40")Dmm (inches)	570(22.44") W× 1750(68.90")H× 950(37.40")Dmm (inches)	570(22.44") W× 1750(68.90")H× 950(37.40")Dmm (inches)
Accessories		PBZ-BP series manuals: Setup Guide (1 pc.), Quick Reference (Japanese: 1 pc / English: 1 pc.), Safety Information (1 pc.) J1 connector kit: Socket (1 pc.), Protection covers (2 pairs), Pins (30 pc.) Heavy object warning label (1 pc.), CD-ROM (1 pc.)				

*1: At an ambient temperature of 23 °C ±5 °C.

*2: When the input signal is in the 100 kHz bandwidth and has a crest factor of 3 or less (the measurement time is at least 10 times the input signal period).

*3: Calibrated with a 1 kHz sine wave.

*4: At 70 %rh humidity or less

*5: At 200 V, 60 Hz for PBZ40-100BP

Appearance

■ PBZ SR Series

The Smart Rack package offers the safety and easy to use, with adopting the know-how of which details can be found in the system.

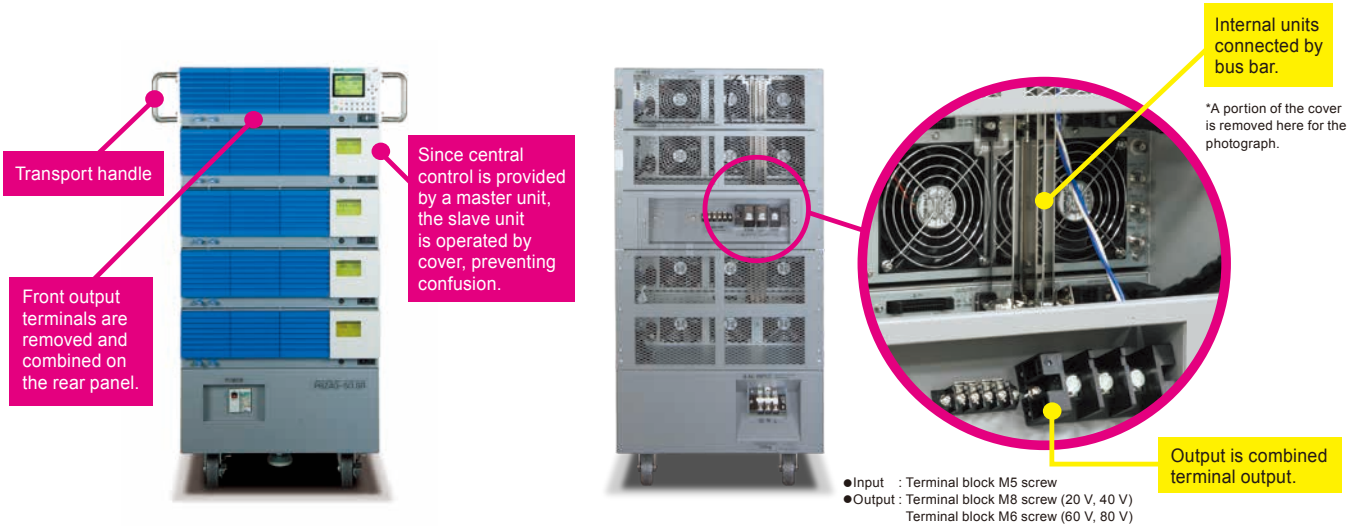

■ PBZ BP Series

The Bipolar Pack package offers the safety and easy to use, with adopting the know-how of which details can be found in the system.

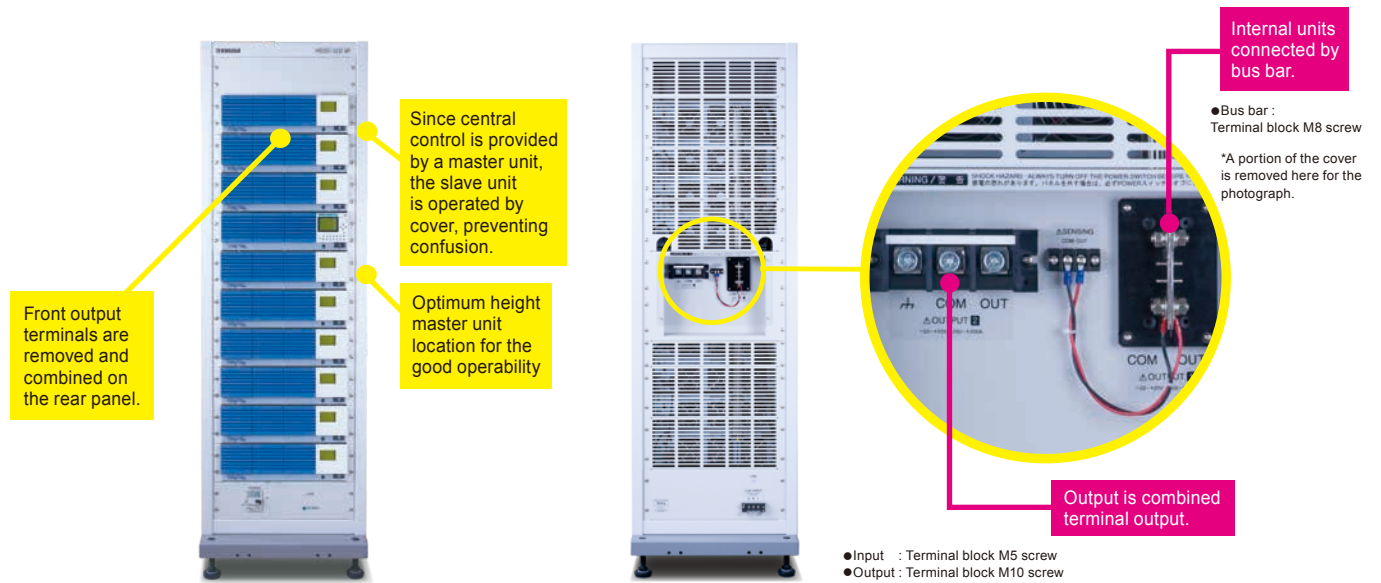

External Dimensions

Unit: mm (inches)

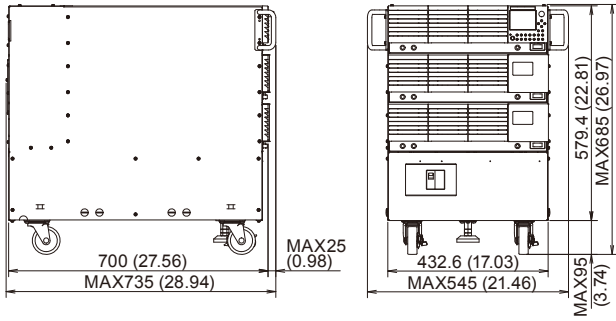

Model PBZ20-60SR, PBZ40-30SR, PBZ60-20.1SR, PBZ80-15SR

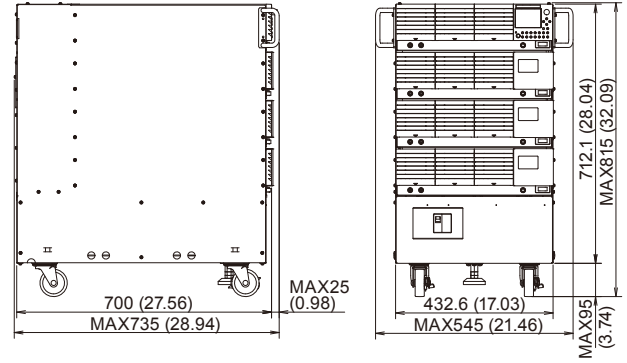

Model PBZ20-80SR, PBZ40-40SR, PBZ60-26.8SR, PBZ80-20SR

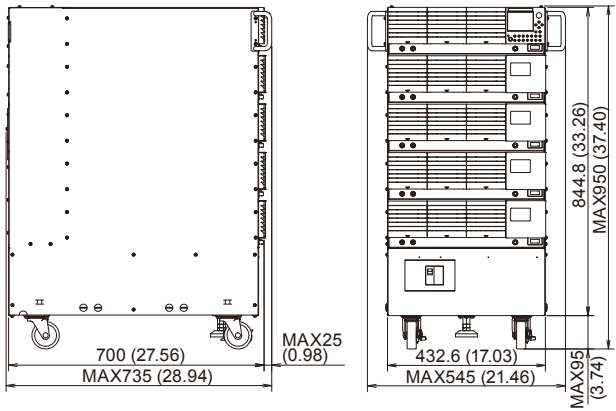

Model PBZ20-100SR, PBZ40-50SR, PBZ60-33.5SR, PBZ80-25SR

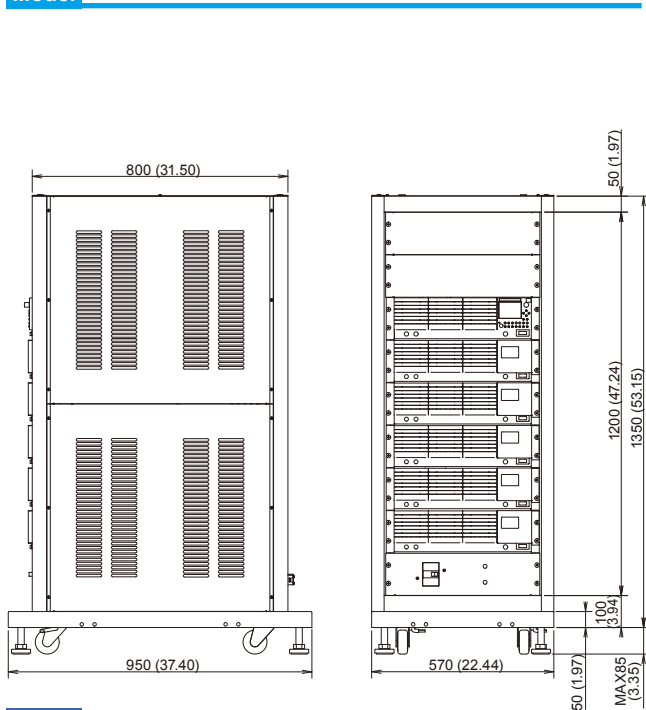

Model PBZ20-120BP, PBZ20-140BP, PBZ20-160BP
PBZ40-60BP, PBZ40-70BP, PBZ40-80BP

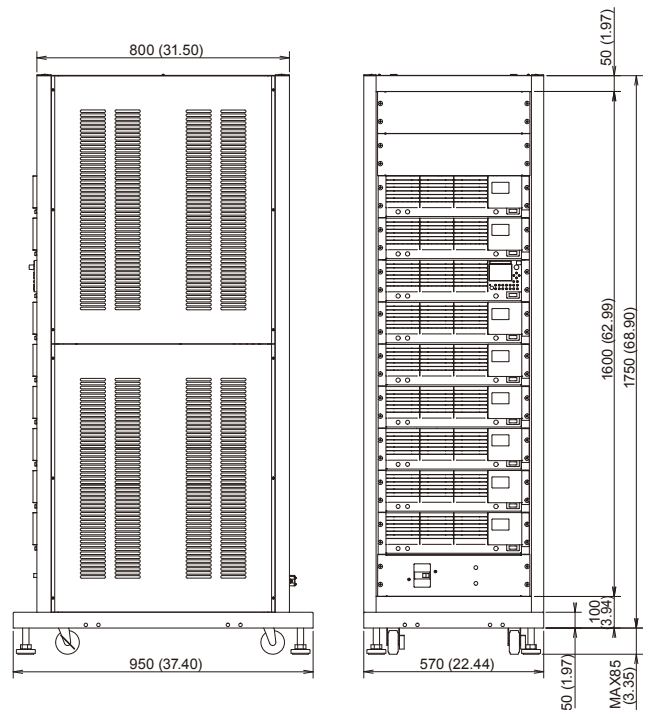

Model PBZ20-180BP, PBZ20-200BP, PBZ40-90BP, PBZ40-100BP

Order Information

Intelligent Bipolar Power Supply

Model	Output rating	Model	Output rating	Model	Output rating
PBZ20-20A	±20 V/ ±20 A	PBZ40-40 SR	±40 V/ ±40 A	PBZ20-140 BP	±20 V/ ±140 A
PBZ20-20	±20 V/ ±20 A	PBZ40-50 SR	±40 V/ ±50 A	PBZ20-160 BP	±20 V/ ±160 A
PBZ40-10	±40 V/ ±10 A	PBZ60-20.1 SR	±60 V/ ±20.1 A	PBZ20-180 BP	±20 V/ ±180 A
PBZ60-6.7	±60 V/ ±6.7 A	PBZ60-26.8 SR	±60 V/ ±26.8 A	PBZ20-200 BP	±20 V/ ±200 A
PBZ80-5	±80 V/ ±5 A	PBZ60-33.5 SR	±60 V/ ±33.5 A	PBZ40-60 BP	±40 V/ ±60 A
PBZ20-60 SR	±20 V/ ±60 A	PBZ80-15 SR	±80 V/ ±15 A	PBZ40-70 BP	±40 V/ ±70 A
PBZ20-80 SR	±20 V/ ±80 A	PBZ80-20 SR	±80 V/ ±20 A	PBZ40-80 BP	±40 V/ ±80 A
PBZ20-100 SR	±20 V/ ±100 A	PBZ80-25 SR	±80 V/ ±25 A	PBZ40-90 BP	±40 V/ ±90 A
PBZ40-30 SR	±40 V/ ±30 A	PBZ20-120 BP	±20 V/ ±120 A	PBZ40-100 BP	±40 V/ ±100 A

Cable Options

Model	Description	Remark
AC8-3P3M-M5C	AC input power cable	8sq Heavy PVC jacketed three-core cable 3 m (Only for SR series)
AC14-3P3M-M5C	AC input power cable	14sq Heavy PVC jacketed three-core cable 3 m (Only for BP series)
TL01-PLZ	Low inductance cable	Maximum allowable current: 100 A, Full length: 50 cm
TL02-PLZ *1	Low inductance cable *2	Maximum allowable current: 100 A, Full length: 1 m (For PBZ20 V, 40 V, and SR series)
TL03-PLZ *1	Low inductance cable *2	Maximum allowable current: 100 A, Full length: 2 m (For PBZ20 V, 40 V, and SR series)
LIC40-2P1M-M6M6	Low inductance cable *2	Maximum allowable current: 50 A, Full length: 1 m (For PBZ60 V, 80 V, and SR series)
LIC40-2P2M-M6M6	Low inductance cable *2	Maximum allowable current: 50 A, Full length: 2 m (For PBZ60 V, 80 V, and SR series)

*1: 2pcs of TL02-PLZ or TL03-PLZ shall be in parallel to be used for PBZ20V BP.

*2: LOW inductance cable can be used only when output is grounded, and cannot be used when not grounded. (For SR Series)

Other Options

Model	Description	Remark
PK01-PBZ	Parallel operation kit	For bench-top
PK02-PBZ	Parallel operation kit	For EIA inch racks
PK03-PBZ	Parallel operation kit	For JIS millimeter racks
OP01-PBZ-A	M8 terminal connection kit	
KRB3-TOS	Rack mount brackets	For EIA inch racks
KRB150-TOS	Rack mount brackets	For JIS millimeter racks; blank panel included
Wavy for PBZ	Sequence creation software	Operating environment: Windows Vista / Windows 7 / Windows 8 / Windows 10
LAN	LAN interface	IEEE488.2/SCPI
VS01	Vertical stand	580(22.83)W × 245(9.64)H × 350(13.78)Dmm(inch); stand only (maximum dimensions)



KIKUSUI ELECTRONICS CORPORATION

1-1-3, Higashiyamata, Tsuzuki-ku, Yokohama, Kanagawa, 224-0023, Japan
Phone:(+81)45-593-0200, Facsimile:(+81)45-593-7591, <https://global.kikusui.co.jp/>

KIKUSUI AMERICA, INC. 1-310-214-0000 www.kikusuiamerica.com



3625 Del Amo Blvd, Suite 160, Torrance, CA 90503
Phone : 310-214-0000 Facsimile : 310-214-0014

KIKUSUI TRADING (SHANGHAI) Co., Ltd. www.kikusui.cn



Room 305, Shenggao Building, No.137, Xianxia Road, Shanghai City, China
Phone : 021-5887-9067 Facsimile : 021-5887-9069

For our local sales distributors and representatives, please refer to "sales network" of our website.

Printed in Japan

Distributor/Representative

■ All products contained in this catalogue are equipment and devices that are premised on use under the supervision of qualified personnel, and are not designed or produced for home-use or use by general consumers. ■ Specifications, design and so forth are subject to change without prior notice to improve the quality. ■ Product names and prices are subject to change and production may be discontinued when necessary. ■ Product names, company names and brand names contained in this catalogue represent the respective registered trade name or trade mark. ■ Colors, textures and so forth of photographs shown in this catalogue may differ from actual products due to a limited fidelity in printing. ■ Although every effort has been made to provide the information as accurate as possible for this catalogue, certain details have unavoidably been omitted due to limitations in space. ■ If you find any misprints or errors in this catalogue, it would be appreciated if you would inform us. ■ Please contact our distributors to confirm specifications, price, accessories or anything that may be unclear when placing an order or concluding a purchasing agreement.

Issue:Nov. 2022 202211PDFEC41